



# INSTRUCTIONS FOR USE, SAFETY AND CARE



# CONTENT

## General notes

General safety instructions.....	5
Electrical components .....	6
Mechanical height adjustment .....	7
Floor protector .....	8
Correct furniture size.....	9
Cleaning and care instructions .....	11

## Tables

Product overview.....	14
Computer tables with sliding top .....	15
Mono-column table .....	16
Side folding table .....	17
Ergotop tables .....	18
School desks height adjustable .....	19
Change tables.....	20
Folding tables .....	21
Drawing tables.....	22
Lecture room.....	22
Tables with mechanical height adjustment .....	23
Row stacking tables .....	25
Tables with electrical height adjustments .....	26



## Chairs

Product overview.....	32
Height-adjustable skid-base chairs.....	34
Chairs with adjustable footrest .....	34
Gas spring chairs .....	36
Chairs with a writing surface .....	36
Office swivel chairs WAVE .....	37
Office swivel chairs STANDARD .....	37
Office swivel chairs PREMIUM .....	39
Upholstered swivel chair .....	42
Swivel spindle stool .....	43

## Corpus furniture

Product overview.....	44
Cupboards (fixed).....	45
Wall units.....	47



Mobile cupboards.....	49
Shelves .....	51
Suspension filing cabinets .....	53
Rolling container .....	54
Desk base units .....	55
Container with pantry pull-out .....	56
Laptop cabinet .....	57
Tablet cabinet.....	58
Hallway cupboards.....	59
Wardrobe shelves.....	59
School satchel shelves.....	60
Hinge adjustment for hinged doors .....	61

### **Lounge furniture**

Product overview.....	63
DOMINO series .....	64
COMBi acoustic partition wall system.....	66

### **Boards**

Multifunctional board system .....	67
------------------------------------	----

# THANKS A LOT FOR YOUR TRUST!

You made a good choice: With your new furniture you have chosen a product that meets the highest standards of quality, safety, environment and health.

The pleasure you get from your product will last especially long if you follow the care instructions that we have compiled for you below. And if you get stuck - we are always ready to listen to you even after the purchase!

## GENERAL SAFETY INSTRUCTIONS

All persons involved in the installation, use, maintenance and repair of the described furniture must...

... observe these operating instructions carefully.

... consider the operating instructions as part of the product.

... retain the operating instructions for the lifetime of the product.

... pass on the operating instructions to each subsequent owner or user of the product.

- Only use the furniture for its intended purpose.
- Lounge furniture seating elements are tested for their intended use according to DIN EN 16139 of test level L2 = heavy use. Lounge furniture tables are tested for their intended use according to DIN EN 15372 of test level 2 = general use.
- Furniture is only suitable for use in (dry) indoor areas.
- Do not store furniture in wet new buildings, in damp cellars, in attics, in containers or the like.
- Do not stand on chairs or tables - DANGER OF ACCIDENTS!
- Do not tilt with chairs - DANGER OF ACCIDENT!
- Check the screwed, riveted and/or welded connections for tightness at regular intervals (e.g. once a year).
- Products must not be used if any component is broken, cracked or missing.
- Do not use abrasive or corrosive cleaning agents. You can find concrete cleaning recommendations in the "Cleaning and care instructions" section or contact your sales representative.
- Do not load tables with more than 220 lb 7 oz.
- Do not load chairs with more than 275 lb 9 oz.
- Before first use, check all fasteners for strength and perform a functional check of all adjustment possibilities.
- Our size classes for tables and seating furniture correspond to the standard sizes specified in DIN EN 1729-1.
- Dust and clean the rails of the sliding panel system regularly every three months and spray with silicone spray or similar if necessary.
- Before using the furniture for the first time, remove all protective devices that have been fitted exclusively for safe transport. Non-observance can lead to damage and loss of function in case of movable mechanisms!

### Explanation of symbols



All safety instructions are shown in yellow and marked with this symbol!

## ELECTRICAL COMPONENTS

The electrical components offer, among other things, several protective contact sockets to which corresponding devices can be connected. The power supply is provided by protective contact mains sockets (230 V/AC, 50 Hz). The devices may only be used indoors in dry rooms.

Please also observe the safety instructions and operating instructions of the other devices that are connected to the respective electrical component.



For safety reasons, you may not convert and/or modify the products. If you use the products for purposes other than those described above, the products may be damaged. In addition, improper use can cause hazards such as short circuits, fire, electric shock, etc.



Please note that there may be additional instructions for safe use for the different models. You will find these instructions in the sections for the individual models. (see table of contents)

## SAFETY INSTRUCTIONS

- Retrofitting must only be carried out by instructed persons!
- Take special care in the presence of children. Children cannot recognise the dangers that arise from incorrect handling of electrical equipment. There is danger to life due to electric shock!
- The installation must be checked before initial operation.
- Damaged parts must not be put into operation.
- Make sure that the connecting cables and the connection cables are not crushed, kinked, damaged by sharp edges or subjected to any other mechanical stress. Avoid excessive thermal stress on the power cord due to excessive heat or cold. Do not change the cables. If this is not observed, the cables may be damaged. This can result in a life threatening electric shock.
- Damage may only be repaired by qualified electricians to avoid hazards.
- Do not operate covered! At higher connected loads the electrical set heats up. There is a fire hazard!
- The sockets are only voltage-free when the mains plug is pulled out.
- Unwind the power cord completely during operation. Lay the cables so that no one can trip over them.
- Never pull the mains plugs out of the socket by their leads, always pull them out of the mains sockets only by the grip surfaces provided.

## COMMISSIONING

- Install the products according to the enclosed installation instructions.
- Plug the power plugs of the connecting cables into a proper grounded power socket (wall socket).

## MAINTENANCE AND CLEANING

- The electrical components are maintenance-free for you. There are no parts inside the components that need to be serviced by you. Therefore, never disassemble the components. Maintenance or repair work may only be carried out by a specialist or specialist workshop.
- Before cleaning, disconnect the components and all connected loads from the mains voltage.
- Never use aggressive cleaning agents, cleaning alcohol or other chemical solutions, as this may attack the housing or even impair its function. Therefore, only use agents with a pH value between 6 and 8 for cleaning or disinfecting the components.
- Use dry, soft and clean cloths for cleaning.

## DISPOSAL

- Electronic devices are recyclable materials and do not belong in the household waste.
- Dispose of the products at the end of their service life in accordance with the applicable legal regulations.
- In this way you fulfil your legal obligations and make your contribution to environmental protection.

## MECHANICAL HEIGHT ADJUSTMENT

This applies to all height-adjustable products:

- Relieve the load on the furniture before adjusting it.
- Make sure that no objects can be trapped.
- Disconnect electrical connections.
- Make sure that the cable length is sufficient.
- Do not extend adjustment elements beyond the maximum adjustment range.
- Place tables horizontally and tilt free.
- Check that the lock nuts and locking screws are tightened after the adjustment process.
- The height adjustment must always be carried out with two persons, unless otherwise described.

The motorised height-adjustable tables comply with the applicable EG directives.

A declaration of conformity can be submitted subsequently on request.

## FLOOR PROTECTOR

- A2S floor protectors are constantly optimised to meet the changing requirements in the areas of application and guarantee a long service life.
- Application areas:  
Felt floor protectors - linoleum, PVC, plastic, parquet plastic floor protectors - carpet, sisal
- in order to guarantee a longer life of floor protectors, regular inspection and maintenance is necessary. Otherwise the floor may be damaged. Regular cleaning of the floors with cleaning agents recommended by the floor covering manufacturers and according to their instructions is a prerequisite for the functionality of the floor protectors.
- Screws and rivets must be checked for tightness every six months, loose rivets must be replaced.
- Floor protectors must be checked every six months and replaced if heavily soiled.
- Felt floor protectors are to be cleaned quarterly from coarse impurities with fine emery paper.
- Floor protectors are wearing parts and are therefore not covered by the warranty granted on the furniture.

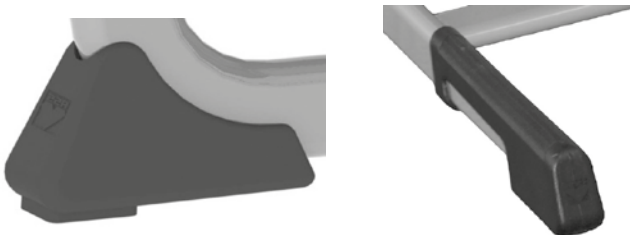

## SPECIAL FEATURES OF A2S FLOORSAFE®

- Protection of the floor by complete support of the floor protector.
- Creates safety: the slip-resistant intermediate component prevents slipping when "tilting".
- Large bearing surface even when "tilting".
- Bolting of the floor protectors from above.



A2S FLOORSAFE®  
back



A2S FLOORSAFE®  
Front



## CORRECT FURNITURE SIZE

Lessons for pupils take place mainly in a sitting position. When sitting, the spine is loaded unilaterally and the lumbar spine is deformed against its natural curvature. Therefore, prolonged sitting leads to postural problems and back pain.

These effects can be mitigated by:

- furniture adapted to the height of the student.
- Dynamic sitting, i.e. frequent change of sitting positions.
- Interruption of sitting with breaks in movement.
- Tables with inclined table tops. (see product area "Tables")

## DETERMINATION OF THE FURNITURE SIZE

DIN EN 1729-1 defines six size classifications. The size of the furniture can be recognised by the coloured markings.

The table below can be used to determine the appropriate table or seat height, taking into account body size.



Size	2	3	4	5	6	7
Pupil size	3' 6.52" - 3' 11.64"	3' 10.85" - 4' 7.90"	4' 4.36" - 5' 2.60"	4' 9.48" - 5' 9.29"	5' 2.60" - 6' 2.01"	5' 8.50" - 6' 9.50"
Table height	1' 8.87" +/- 0.79"	1' 11.23" +/- 0.79"	2' 1.20" +/- 0.79"	2' 3.95" +/- 0.79"	2' 5.92" +/- 0.79"	2' 8.28" +/- 0.79"
Seat height	1' 0.20" +/- 0.39"	1' 1.78" +/- 0.39"	1' 8.87" +/- 0.39"	1' 4.93" +/- 0.39"	1' 6.11" +/- 0.39"	1' 8.08" +/- 0.39"

## ERGONOMIC SITTING

When choosing furniture, it should be taken into account that a first-grader can grow up to 2' 7.50" taller before he or she is fully grown. Therefore, every six months it should be checked whether the tables and chairs are still at an appropriate height for the students.

Description of ergonomic sitting on furniture of the right size using a sketch with explanations:

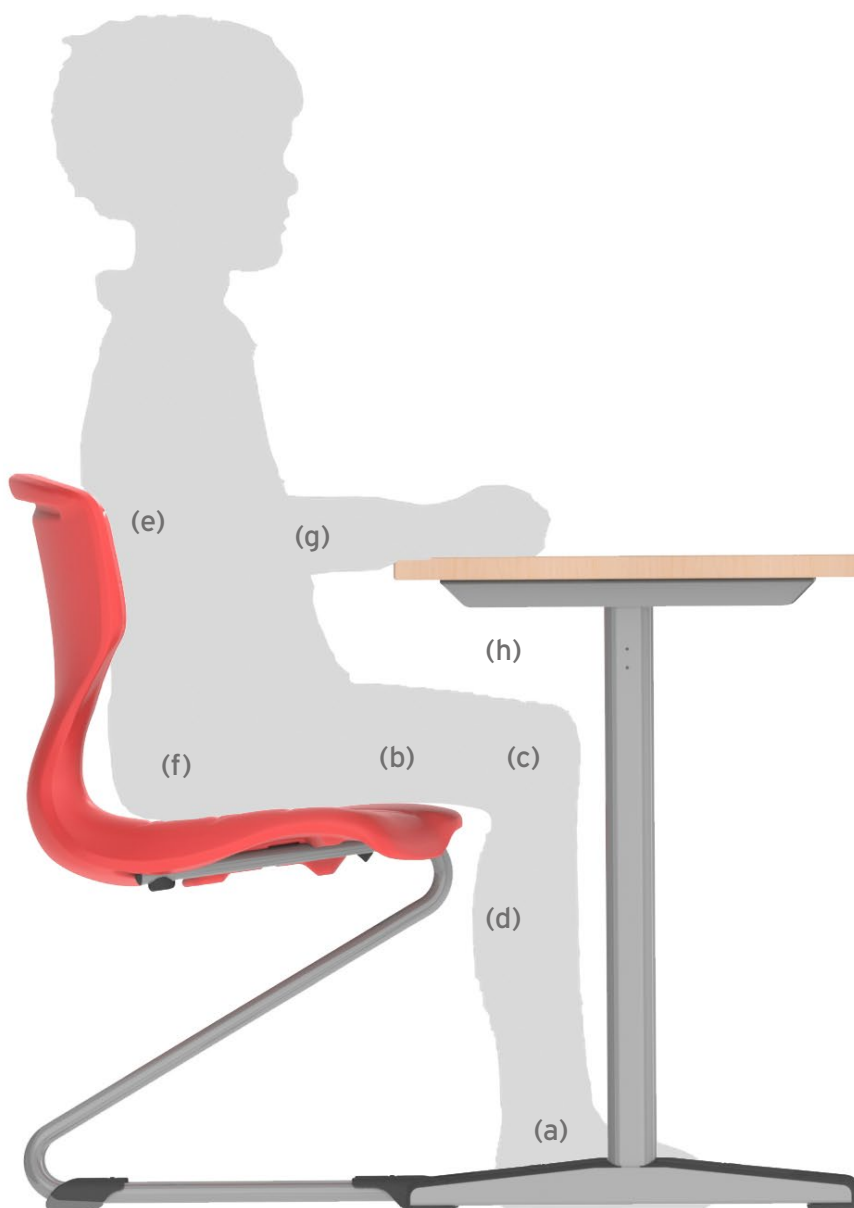

### Seat height

Both feet touch the ground completely (a). The thighs rest horizontally on the seat surface (b). The upper and lower legs form a right angle (c).

### Seat depth

The back of the knee and the back of the lower leg do not touch the front edge of the seat (d). The back touches the backrest (e). Thigh and upper body form a right angle (f).

### Table height

With arms hanging down, the tip of the elbow is at table top height (g).

### Legroom

There is room for movement between the table base and thigh (h).

## CLEANING AND CARE INSTRUCTIONS

### GENERAL CARE INSTRUCTIONS

Remarks on the use of products with solid wood elements and table tops:

- The products should be protected from direct sunlight.
- They should not be located in the immediate vicinity of heat sources such as radiators, heaters, etc.
- Mechanical damage to wooden surfaces is not recognised as a product defect.

### MELAMINE RESIN COATED SURFACES

(PAGHOLZ®, WOODMARK®, WOODPLAC® etc.)

These are pore-tight and therefore easy to clean surfaces.

Light soiling should be cleaned with a moderately damp cloth or sponge. Stronger soiling can be removed with a gentle cleaning agent or soapy water. Then remove excess water with a cloth or sponge.

Adhering lime residues can be removed with a warm 10 % acetic or citric acid.

It is essential to remove any soiling with felt pens, ballpoint pens or similar before it dries up.

It is essential that you have a specialist remove stubborn dirt, e.g. paint, glue or dried markings from pens - our customer service will be happy to advise you.



**Do not use harsh and/or abrasive cleaning agents!**  
**Do not use cleaning cloths or sponges that can leave scratches on the surfaces!**

### FABRIC COVERS

Brush out textile covers at regular intervals with a soft brush or vacuum with an upholstery nozzle. Contamination in upholstery fabrics is easiest to remove immediately after it has occurred. Before removing the stain, test the colour fastness and surface change on a concealed area with a cleaning agent! For cleaning, dab damp stains with an absorbent cloth. Apply cleaning agent to a white cloth and carefully remove the stain. Avoid strong rubbing or chafing, this can permanently damage the cover fabric! Residues can be after-treated with a suitable upholstery shampoo. If necessary, have the furniture cleaned by a specialist.



**The instructions for use of the respective cleaning agent must be observed!**  
**The basic cleaning must always be left to a specialist.**

### NATURAL AND ARTIFICIAL LEATHER

If possible, remove contamination as soon as it occurs with lukewarm water and a damp cloth. The use of a standard microfibre or cotton cloth is particularly recommended. For heavier soiling use a warm, mild soapy water and a soft hand brush.

The cleaning process may have to be repeated several times. Then wipe off the remains of the cleaning agent with a damp cloth and lukewarm water. If you are using special leather care products, be sure to test them beforehand on a concealed area!



Please always follow the dosage instructions of the respective manufacturer when using commercially available cleaning agents. Furthermore, no cleaning agents containing oil and grease should be used. Dry cleaning is not suitable for artificial leather surfaces. Dried-in substances or substances that have penetrated for a longer period of time can only be removed to a limited extent.



The surfaces of artificial leather materials are not resistant to solvents, chlorides, polishing agents, washing-up polishes and aerosol sprays. Please note that staining of the upholstery by jeans or other textiles is excluded from any manufacturer's warranty.

## POWDER-COATED OR CHROME-PLATED SURFACES

The easy-care surface of powder-coated or chrome-plated furniture can be cleaned easily with a moderately damp cloth or sponge. Stronger soiling can be removed with a gentle cleaning agent or soapy water. Then treat the surface with clear water.



**Do not use harsh and/or abrasive cleaning agents!**  
**Do not use cleaning cloths or sponges that can leave scratches on the surfaces!**

## PLASTIC COMPONENTS

Components made of plastic (PP), such as floor protectors, cover plugs, etc., do not usually require any special care. Light soiling should be cleaned with a moderately damp cloth or sponge. Stronger soiling can be removed with a gentle cleaning agent.



**Do not use harsh and/or abrasive cleaning agents!**  
**Do not use cleaning cloths or sponges that can leave scratches on the surfaces!**

## GLASS SURFACES

Remove light soiling with a moderately damp cloth or sponge. More severe soiling should be treated with water and a commercial glass cleaner. After cleaning, remove the glass surface with a rubber lip wiper and wipe with a dry cloth.

## PLEXIGLASS SURFACES

Clean surfaces using warm water and a soft clean sponge. Avoid dry rubbing and if necessary use a mild soap or a slightly acidic, neutral or slightly alkaline cleaning agent. Then rinse well with clean water and dry with a leather cloth or a moist cellulose sponge. Antistatic treatment is recommended afterwards.

Fresh paint splatter, grease, etc. can be removed before drying with a soft cloth and ethanol or petroleum ether by rubbing lightly and, as described above, washing and rinsing thoroughly afterwards.



**Do not use abrasive or strongly alkaline cleaning agents, acetone, benzene, leaded petrol or carbon tetrachloride! Never scrape with razor blades or other sharp objects!**

## LINOLEUM SURFACES

Wipe surfaces regularly with a moderately damp cloth and, if necessary, add some neutral cleaning agent. In the case of heavy soiling, treat the stains with undiluted neutral cleaner or a cleaning emulsion containing wax (pH value <9). Then always wipe with clear water and dry with a soft cloth. In case of doubt, our customer service will be happy to advise you.



**Do not use harsh and/or abrasive cleaning agents!**

## STEEL ENAMEL PANEL SURFACE (GREEN)

To reduce future streaking, completely coat the surface with white chalk for initial cleaning and then wash it off with a damp cloth or sponge. Now treat the surface with a neutral cleaner and wash it off with plenty of water after a short time.

Clean board surfaces after each use with a well damp sponge or cloth and wipe off the water with a rubber lip wiper. Aluminium edgings should also be wiped dry after cleaning. Treat the surface with a neutral cleaner at least once a week and wash it off with plenty of water, especially if oily chalk is used. Adhering lime residues can be removed with a warm 10 % acetic or citric acid.



**Do not use harsh and/or abrasive cleaning agents!  
Do not use board markers on the green board surfaces!**

## STEEL ENAMEL PANEL SURFACE (WHITE)

Dry cleaning is usually sufficient after use with pens specially designed for whiteboards. However, the board surface should be cleaned at least once a week with a neutral cleaner and then rinsed off with plenty of water. Make absolutely sure that no residues of the cleaner remain on the surface. These impair the later dry cleaning and so called "ghost writings" remain. Even fingerprints can leave behind such an invisible film. This type of contamination can, however, in most cases be remedied with sufficient water. Additionally, wipe all aluminium frames dry after cleaning. The board surface must be dry before you write on it again!

Light soiling must be removed before it dries up. For heavy soiling, the board surface can be cleaned with water containing detergent and, in exceptional cases, with white spirit. We recommend having the panel cleaned by a specialist if it is heavily soiled. Our experts will be happy to advise you on this.



**Only use board markers suitable for whiteboards!  
Always clean the surface thoroughly with plenty of water!**

## PRODUCT OVERVIEW

MODEL	NAME
10vw.xyz	1000 series   Group tables   Metal table system, welded
10vw.xyzM	1000 series   Group tables   Metal table system, welded
1026.xyz	Row stacking tables
20vw.xyz	2000 series   Group tables   Metal table system, dismountable
2005.xyz	2000 Series   Rectangular tables
2006.xyz	2000 series   Circular tables
2007.xyz	2000 series   Elliptical tables
18vw.xyz	18 series   Computer tables
1911.xyz	1911 series   Motorised height adjustable tables
1960.xyz	1960 series   Computer tables
31vw.xyz *	SOLID series   SOLID tables
3639	CHANGE Series   Standing tables PAGHOLZ®
3660.xyz *	3660 series   Side folding tables
39vw.xyz	39 series   Folding tables
558w.xyz	558 series   Office desks, motorised height adjustment
58yz	58 series   Writing/meeting tables   Table system wood
70z0	70s series   Classroom tables   Wooden skid tables
705w.xyz	70 series   Teacher's desks   4-legged tables wood
72y0/73z0	72/73 series   Classroom tables   Skid tables
7270/7270.002	CHANGE Series   School desks
7280.00z	728 series   Classroom tables   4-legged stacking tables
7281	728 series   Classroom tables   4-legged stacking tables PAGHOLZ®
735w.xyz	72/73 series   Teacher's desks   Skid tables
752w.xyz	75 series   Teacher's desks   C-form tables
753z	75 series   Classroom tables   C-form tables
757w.xyz	85/95 series   Teacher's desks   4-legged tables oval tube
76vw.xyz *	76 series   Classroom tables   Height-adjustable mono-column tables
769z	76 series   Height-adjustable classroom tables   Centre column tables
77yz	77 series   Height-adjustable classroom tables   C-form tables
85vw.xyz	85 series   Classroom tables   Centre column tables
938w.xyz	DOMINO   tables
953z	95 series   School desks   C-shape double-column base

For all products mentioned here, the general instructions at the beginning of the document apply. All models listed stand for the respective model series.

\* The tables comply with test level 3 (heavy use) of DIN EN 15372.

## COMPUTER TABLES WITH SLIDING TOP

- before moving the table top, make sure that no objects or cables can be trapped.



**Disconnect all mains connections before!**

- Check that all cables are of an appropriate length.
- To move the table top, release the central lock.
- Disconnect all mains connections before laying the cables.
- Where individual parts of office furniture are firmly connected electrically (e.g. by means of interlinking), they must also be mechanically connected to each other.
- All cables that are fed must have strain relief.
- The office furniture shall be equipped with ready-to-use work equipment and components which comply with the rules of electrical engineering.

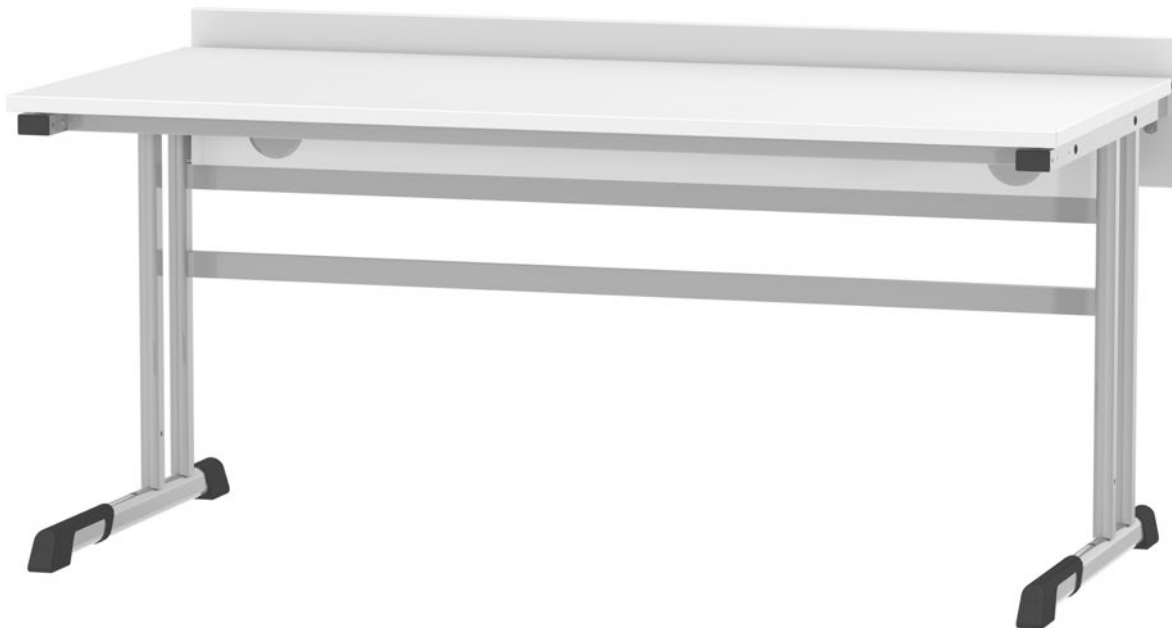

## MONO-COLUMN TABLE

### Models 76vw.xyz

Applies to all mono-column tables with height adjustment by gas lift:

- overloading leads to loss of function of the height adjustment and can damage the gas spring.
- Do not climb onto the tables.
- When operating the height adjustment, keep a safe distance from surrounding furniture (danger of jamming).
- Make sure that electric cables are sufficiently long.
- Before moving, place tables in lowest position. Check the route for obstacles and trip hazards (electric cables, loose floor coverings or similar). Loosen cable connections.
- The use is limited to the interior. Moving on unsuitable floors such as pavement will damage the castors.



Manipulation of the hand release, stand column and castors only by instructed personnel.  
Gas springs are under pressure! Do not open or heat up!

## SPECIAL FEATURES TYPICAL FOR THE MODEL



Model 7612.076



Model 7614.097

Lift the table at the front edge until the castors are in contact with the floor, move and set down. Turn the levelling feet in or out for uneven floors.



Model 7615.138



Model 7616.097



Model 7618.0yz

The stop device must always be operated on all rollers to secure the table against rolling away. It is a total locking device that locks both the rolling movement of the castor and the rotation of the castor on the frame.



## SIDE FOLDING TABLE

Models 3660.xyz

This applies to all side folding tables:

- Overloading can lead to damage to the folding mechanism.
- Do not climb onto the tables.
- When operating the folding mechanism, maintain a safe distance from surrounding furniture (danger of jamming).
- Before the procedure, check the route for obstacles and tripping hazards (electric cables, loose floor coverings, etc.)
- The use is limited to the interior. Moving on unsuitable floors such as pavement will damage the castors.



Manipulation of the folding mechanism, 2-hand safety operation and castors only by instructed personnel!



### Operation



Pull the release lever with both hands and fold it 90°.

The folding mechanism is triggered by a continuous release lever with robust 2-hand safety operation. Always use both hands to ensure that the table top can be folded up safely. The table top locks in the folded up position.

## ERGOTOP-TABLES



Model 7690



Model 7692



Model 7695



Model 7697



- A Tilt adjustment
- B Adjustable feet for floor levelling
- C Crank handle for height adjustment

The gears of the height adjusters are maintenance-free.

## SCHOOL DESKS HEIGHT ADJUSTABLE

### Adjusting the table heights

#### Models 77yz

Model series similar to figures:

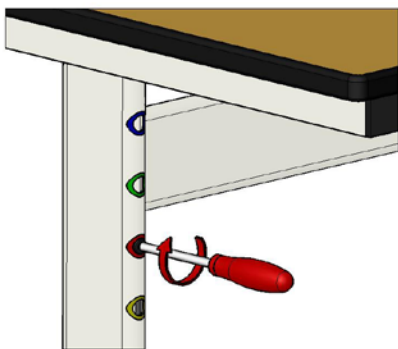

Figure 1

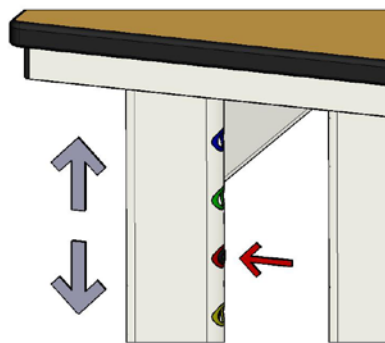

Figure 2

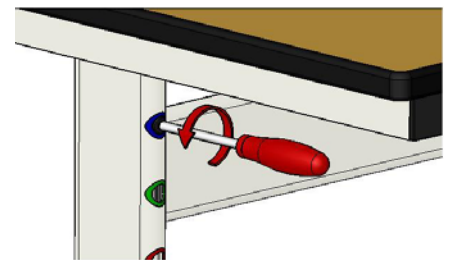
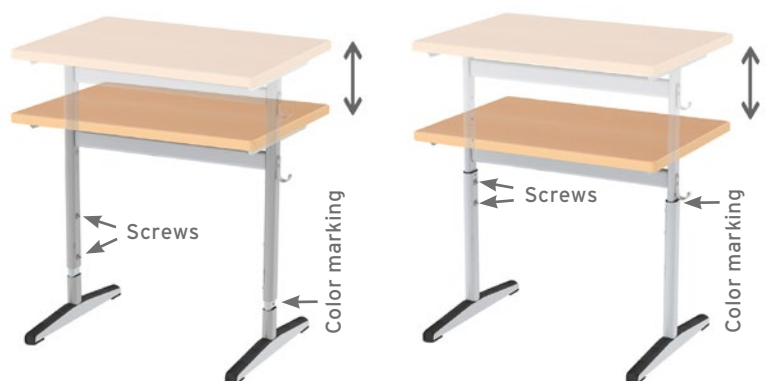

Figure 3

- Screw in the locking screw on the first table leg (Fig. 1).
- Press the button and set the desired table height (Fig. 2).
- Then unscrew the locking screw again (Fig. 3).
- Proceed in the same way for the second table leg (Fig. 1-3).
- Both table legs must always be adjusted to the same height!

#### Models 8580.xyz and 8582.xyz

- Place the table on its side and unscrew the screws.
- Move the table legs to the desired position, observing the colour marking.
- Screw in screws and check annually for tightness!



8580.xyz

8582.xyz

## CHANGE TABLES

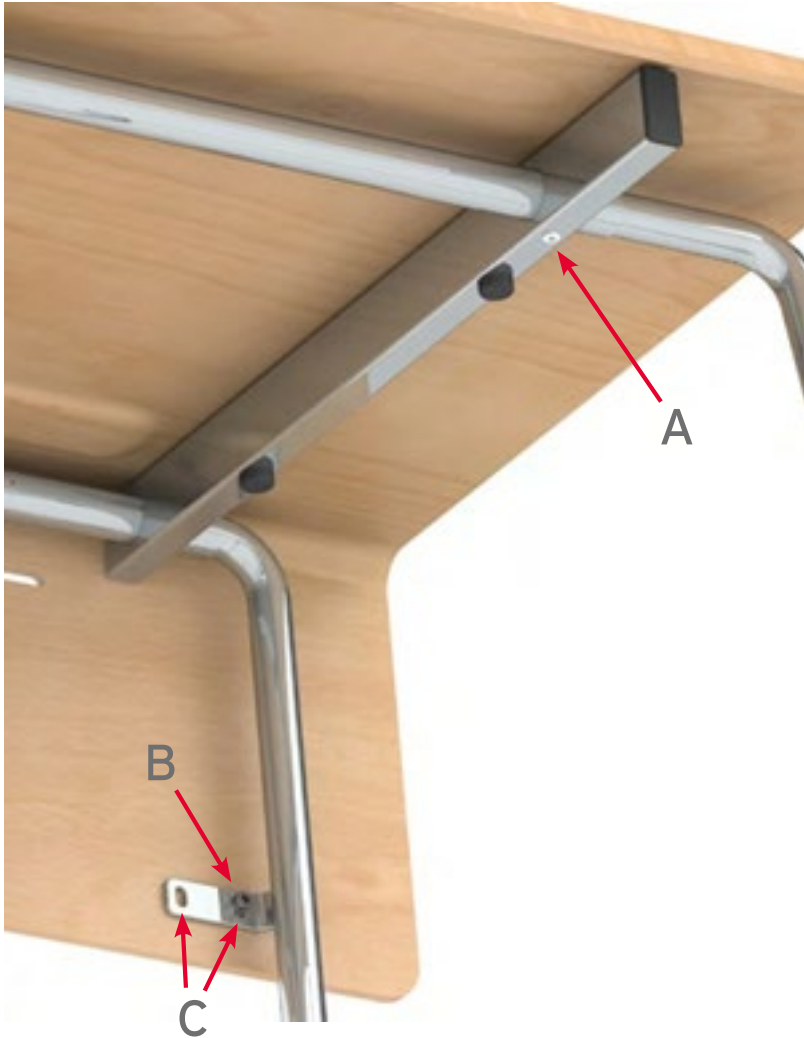

To change the function from table row to stackable table, proceed as follows:

- loosen screws (A) and unscrew screws (B).
- Push in / pull out the frame.
- Tighten the screws (A) and screw in the screws (B) through a suitable slotted hole (C).



Table stacked (frame extended)



Table row (frame inserted)

## FOLDING TABLES



Model 3930.xyz



Model 3920.xyz



Model 3907

- Folding tables are delivered with snap-in fitting or gas spring



Gas springs are under pressure! Do not open or heat up!  
Replacement only by instructed personnel!

- Legs lock automatically when folded (Fig. 1).
- Unfold the legs by pulling on the legs until they lock.
- Before folding the legs, press the locking lever (Fig. 2) or locking sleeve (Fig. 3).

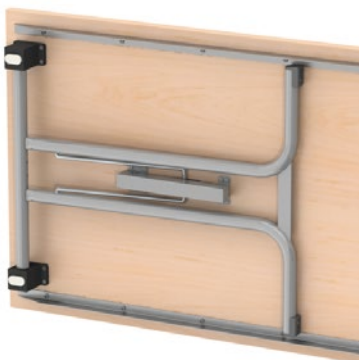

Figure 1

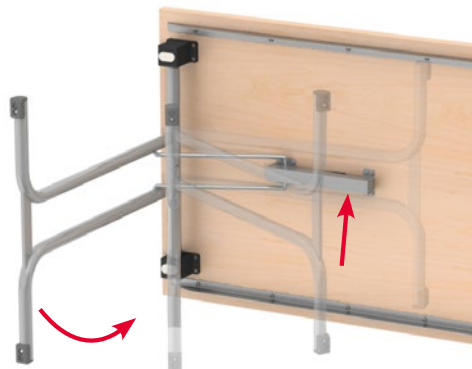

Figure 2



Figure 3

The tables are tested according to DIN EN 15372, level 3 (= highest level). As a result, they can withstand heavy use, such as that which occurs in the following areas of application according to DIN EN 15372: Nightclub, police station, transport centres, public areas in hospitals, casinos, retirement homes, changing rooms in gyms, prisons, barracks.

## DRAWING TABLES

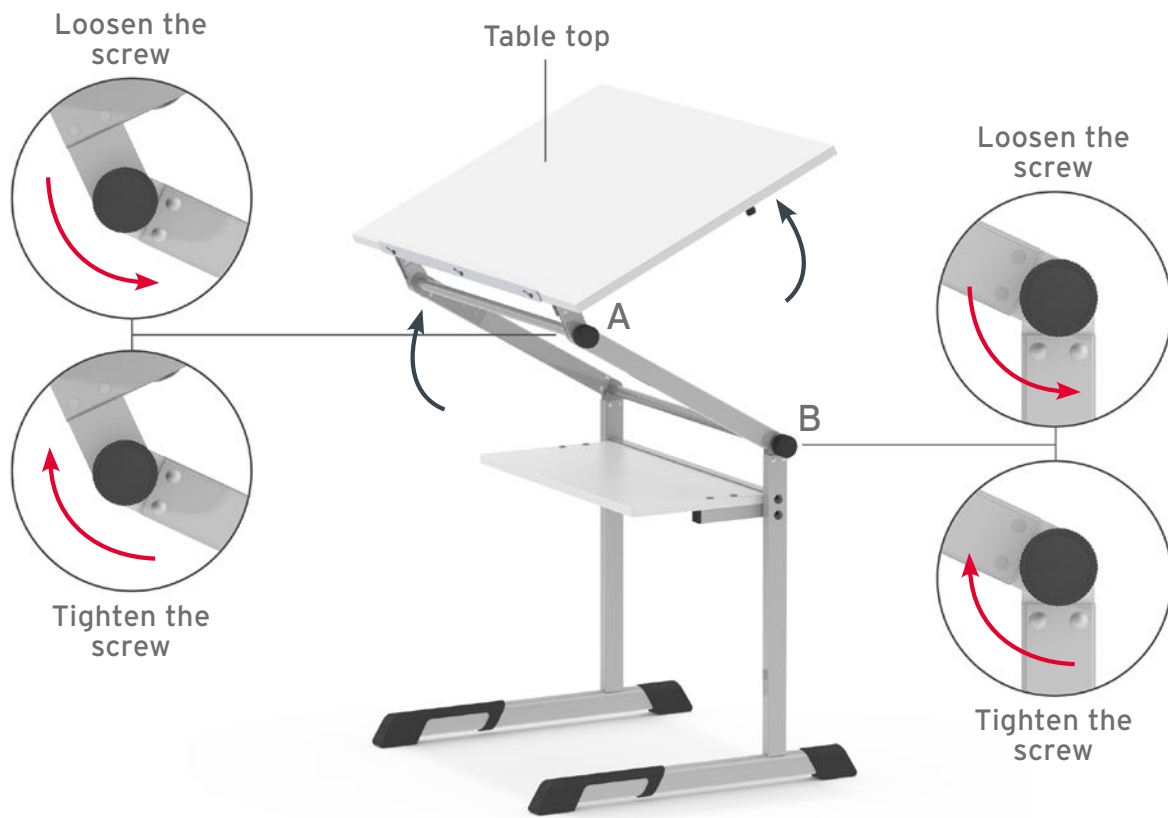

- The table top can always be adjusted by two persons.
- Hold the table top with both hands and loosen screws (A or B).
- Adjust the top so that the table cannot tip over during use. Danger of tipping over if incorrectly adjusted!
- Retighten screws (A or B).
- Only now release the table top and check the stability again.

## LECTURE ROOM

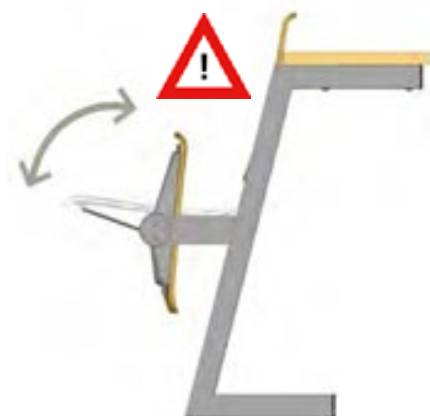

When folding up and down, make sure that no objects are trapped behind the seat!

## TABLES WITH MECHANICAL HEIGHT ADJUSTMENT

### MODULE TABLE SYSTEM



#### Standard height adjustment (0,394 Inch)

Series 10vw.xyz, 10vw.xyzM and 20vw.xyz

- set the desired height by turning the adjustable foot (A). Adjustment possible by manual force or with an SW 27 wrench.

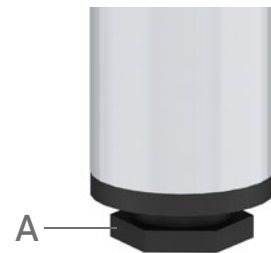

#### Tool-free height adjustment (3,937 Inch)

Series 20vw.xyz

- Loosen lock nut (A).
- Set the desired height by turning the adjusting foot (B), check using the scale in the adjusting foot (B).
- Tighten lock nut (A) moderately by hand.

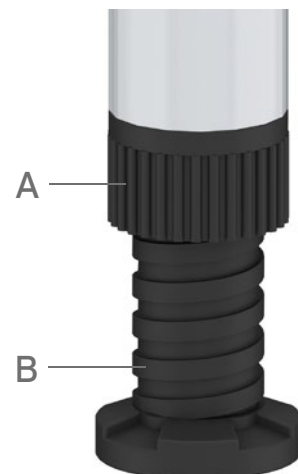

## Raster height adjustment (GK 3 - 7)

Series 10vw.xyz and 10vw.xyzM

- Screw in screw (A) using an Allen key SW 4 until the inner tube (B) can be moved.
- Set the desired height/size class by sliding the inner tube (B) in or out. Check using the scale (C) on the inner tube. The currently set height is displayed on the inner tube at the lower edge of the outer tube.
- To fix the inner tube, unscrew screw (A) again using an Allen key.

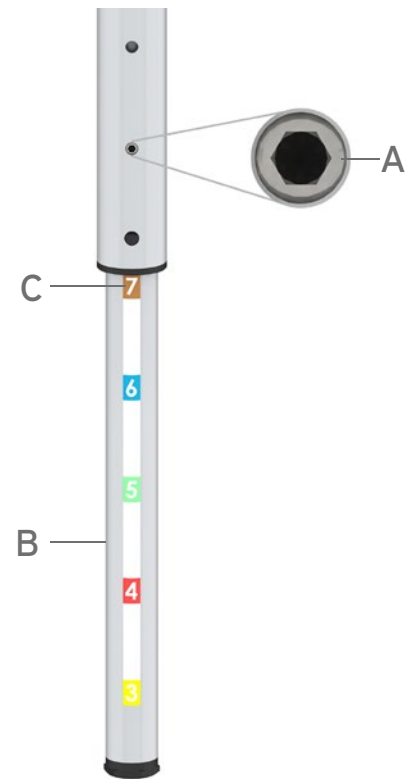

## Crank height adjustment (7,87 Inch)

Series 20vw.xyz

- Insert crank (A) and adjust the telescopic tube (C) to the desired height according to scale (B).
- Insert the crank handle on the second side part and repeat the procedure.

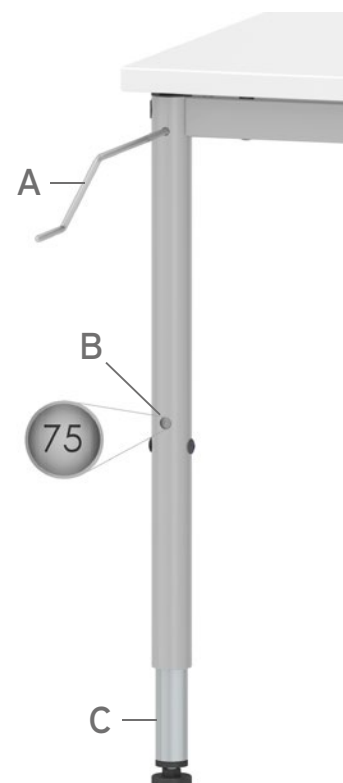



## ROW STACKING TABLES

Models 1026.xyz

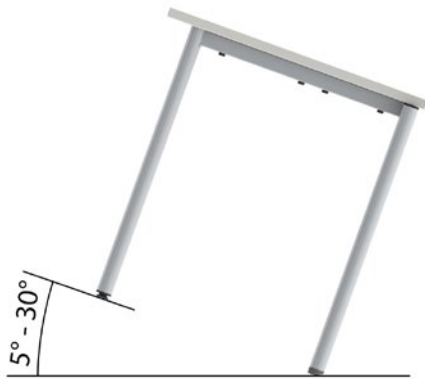

### Move

Row stacking tables by the tabletop, lift easily and move via the integrated casters.



### Adjust height compensation

After delivery, the height of the floor protectors must be adjusted so that the table is level!

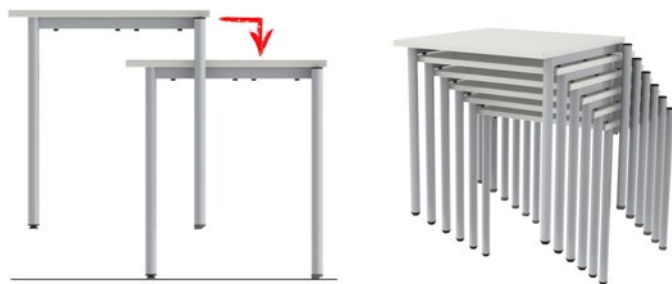

### Stacking

Max. 6 pieces stackable

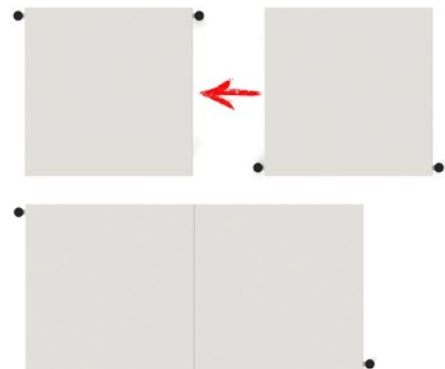

### Side by side rows

Place the tables in a row by turning the next table 180°.

## TABLES WITH ELECTRICAL HEIGHT ADJUSTMENTS



Models 5580.xyz



Models 5585.xyz  
Models 5586.xyz



Models 1911.xyz

### Before commissioning

- It must be ensured that the operating voltage of 230 V is correctly applied to the controller.
- The tables are to be placed horizontally and tilt free by turning the levelling feet in or out.

### During operation

- Disconnect the power supply in case of problems with the lifting column or malfunctions of the control unit.
- Electrically height-adjustable desks may only be used in an environment that corresponds to their protection class (IP 20).
- There is a danger of crushing when changing the table top position. Therefore, make sure that there are no objects or persons in the danger zone and that no one reaches into the danger zone.
- A permanent one-sided load can cause damage to the lifting columns.

### Cleaning

Only detergents and disinfectants with a pH value between 6 and 8 may be used.

### Special features model series 558z

- The duty cycle is 10 % at maximum load 2 minutes of operation, 18 minutes rest.



**Exceeding the duty cycle may reduce the life of the system!**

- The maximum load of 176 lb 6 oz per leg (including table top) must not be exceeded.
- Height adjustment from 2' 0.41" to 4' 2".
- The drive system has a noise level of 55 dB(A)
- Adjustment speed 1.5"/s

## Special features model series 1911.xyz

- To avoid overheating of the motor, the brake and the spindle nut, it must not be switched on for more than 6 minutes per hour or 2 minutes in continuous operation.



Exceeding the duty cycle may reduce the life of the system!

- The maximum load of 220 lb 7 oz must not be exceeded.
- Height adjustment from 2' 1.2" to 4' 2.79".

## Operation hand switch for model series 558w.xyz

The DESK Panel is available in two versions:

- DPG1K for up/down function
- DPG1C for up/down function, 4 stored positions, memory, display (not Bluetooth® functional)



DPG1K



DPG1C

Please note the manufacturer's manuals for the manual switch and control system:

<https://www.linak-us.com/segments/deskline/start/>

## DPG1K

The desk panel is operated via toggle switch.

1. Press and hold the DPG1K upwards to move the table up. Press and hold the DPG1K down to move the table down.
2. Release the DPG1K when you have reached the desired position.

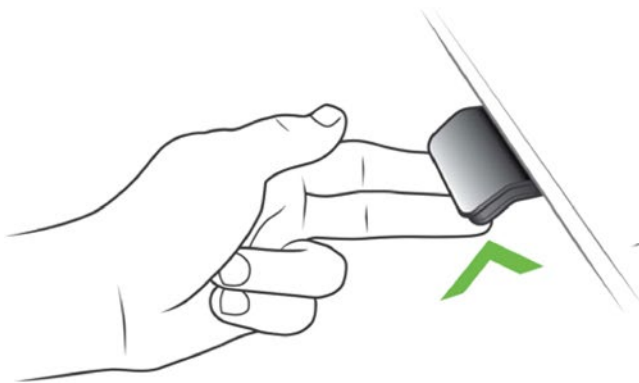

Press and hold the DPG1K to move the table up.

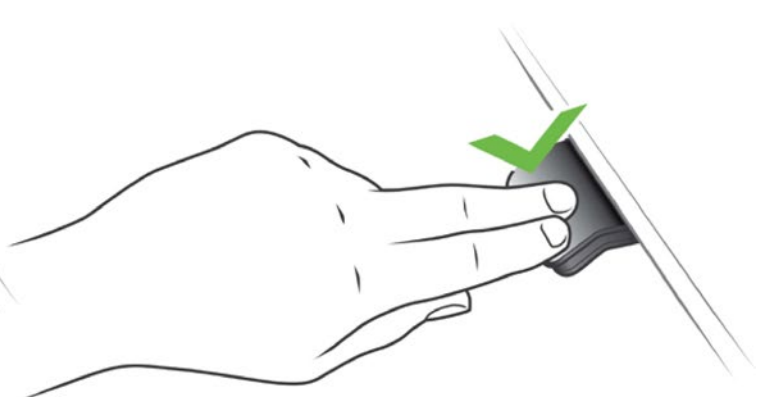

Press and hold the DPG1K to move the table down.

## DPG1C

The DPG1C has three control buttons.

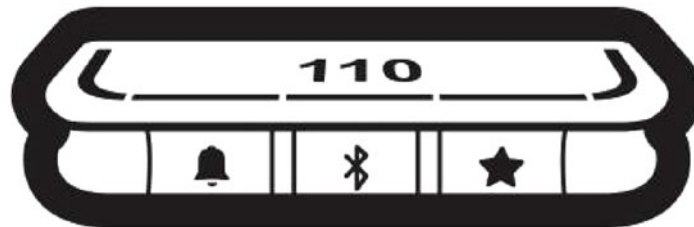

Every key has a certain function:

Symbol	Description	Function
🔔	Memory	Set memory
📶	Operating button	Used to set certain functions
★	Favourites	Save favourite positions

## Display

The DPG1C has an OLED display displaying the table's height and many other texts as orientation aid.

### Adjusting the displayed height of the desk

If the height shown on the display is incorrect, it can be adjusted.

1. Press the 🔔 and the 📶 key on the DPG1C simultaneously for five seconds and the height begins to flash in the display.
2. Press the DPG1C to change the displayed height without moving the desk.  
Press up to increase the displayed height and down to reduce the displayed height.
3. Press any key to confirm the height or wait 10 seconds until the confirmation occurs automatically.

### Changing the unit of measure

The unit of measure shown in the display can be set to cm or inch.

1. Press the ★ and the 📶 key on the DPG1C simultaneously for five seconds and the current unit of measure will flash in the display.
2. If, for example, "CM" flashes in the display, press DPG1C once to change the unit of measure to inch. Now "INCH" flashes in the display.
3. Press any key to confirm the unit of measure or wait 10 seconds until the confirmation occurs automatically.

### The desk panel is operated via toggle switch.

1. Press and hold the DPG1C upwards to move the table up. Press and hold the DPG1C down to move the table down.
2. Release the DPG1C when you have reached the desired position.

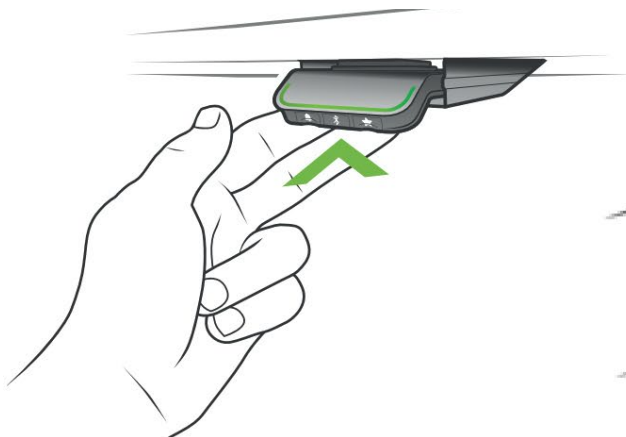

Press and hold the DPG1C to move the table up.

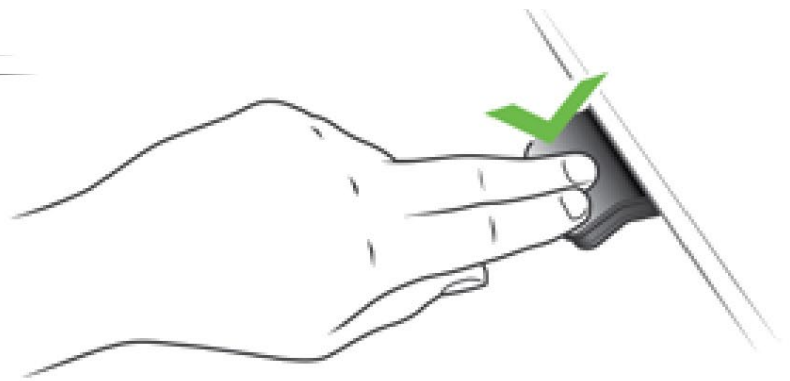

Press and hold the DPG1C to move the table down.



## Limiting the table height

If the desk cannot be operated in its entire traversing range (e.g. a shelf is blocking the upwards movement or a filing cabinet will be placed under the desk and blocks the downward movement), you can set an upper and a lower limit for the height of the desk.



### Remark:

It must always be possible to move the desk to its minimum height if an initialisation is required. During the initialisation, the elements located under the desk must be removed.

## Setting the upper limit

1. Set the table to the maximum permissible height.
2. Press  and simultaneously the DPG1C for 8 seconds upwards until the light flashes.
3. Release  and the DPG1C.

## Set the lower limit

1. Set the table to the minimum permissible height.
2. Press  and simultaneously the DPG1C for 8 seconds downwards until the light flashes.
3. Release  and the DPG1C.

## Favourite positions

Saving favourite positions 1 and 2

1. Set the desk to a preferred position.
2. Press the  key for two seconds.



The light bar flashes white twice to indicate that the position is being saved. Only once the light bar is constantly white has the position been saved. The display shows the stored position with a ★ and a position number. The number next to the ★ shows the sequence in which the positions are saved.

- First position saved: The ★ is displayed next to the "1".
- Second position saved: The ★ is displayed next to the "2".

If the user sets the desk to a different position and saves this position, he overwrites the favourite position (1 or 2), which is closest to the current position.

## Saving favourite positions 3 and 4

1. Press the ★ key to switch the display between the four favourite positions (with the ★ position number next to it).
2. Cycle through these four preferred positions in the display and choose the position under which the current position is to be saved.

For example, a user would like to save the current position as favourite position 3:

3. Press the ★ key and switch to the ★ with "3" next to it.
4. Press the ★ key for two seconds and the favourite position is saved.

## Remark:

The favourite positions 3 and 4 can be disabled via the DPG configurator (from DPG SW version 1.29).

## Approaching favourite positions

After saving the favourite positions, these can easily be approached by pressing the DPG1C.

1. Pressing and holding - if a stored position has been reached, stops the table.
2. Release the DPG1C within one second.

In this way, the user can easily switch between the sitting and standing height without looking at the DPG1C. While the table is moving, the display indicates the table height. When a favourite position has been reached, the display indicates a ★ and the position number.

The DPG1C stops at all saved favourite positions, which means up to four different positions over the stroke length of the desk.

If the table stops at a saved position, the user may

- hold down DPG1C longer than one second

or:

- release the DPG1C and press it again.







The table moves past the stored position and continues the movement.

## Operation hand switch for model series 1911.xyz

The DESK Panel is available in two versions

- DP1K for single/parallel operation without memory function.
- DP1U for single/parallel operation with memory (three memory positions).

The two arrow keys are used for single/parallel running and the others for the memory function.

-  Table up
  -  Table down
  -  Save
  -  Memory position 1
  -  Memory position 2
  -  Memory position 3
- } DP1U only

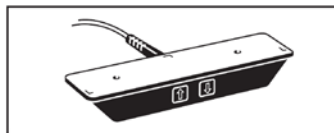

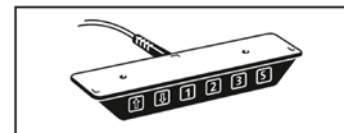

Desk Panel DP1K



Desk Panel DP1U



## Single/parallel run

The arrow keys   start the columns. The function is only activated as long as the keys are pressed.

## Save

- Press 
- Press within 2 sec. ,  or 

## Memory function

Memory ,  and  (DP1U only) start the memory function. The column(s) moves to a preset position.

## PRODUCT OVERVIEW

MODEL	NAME
31vw.xyz *	SOLID series   SOLID benches
320x/33yz	72 series   4-leg chairs PAGHOLZ®
3435	72 series   PAGHOLZ® slide chairs with row connection
52yz*	52 series   4-legged chairs solid wood
6100	School chairs   C-form chairs plastic
6690.z00	Stools   Hallway furniture system
7000	7000 solid wood chairs   School chairs   Skid-base chairs
7097	7097 solid wood chairs   4-legged chairs
71z0	71 series   School chairs   C-shaped chairs WOODPLAC®/Multiplex
713z	71 series   Height-adjustable school chairs   Skid-base chairs WOODPLAC®
720z	72 series   PAGHOLZ® slide chairs
7307	72 series   C-form chairs PAGHOLZ®
741z	WAVE series   Conference chairs   4-leg chairs PAGHOLZ®
7416.04z	Footrest chairs   Cantilever chairs PAGHOLZ®/FLEX
74z4	WAVE series   Conference chairs   Cantilever chairs PAGHOLZ®
7440	7440s   4-legged chairs with PAGHOLZ® seat and back
747w.xyz	74 series   Large capacity chairs   4-legged chairs multiplex
780z	78 series   PAGHOLZ® slide chairs
7802	CHANGE Series   PAGHOLZ® slide chairs
7811	78 series   C-form chairs PAGHOLZ®
7813	CHANGE Series   C-form chairs PAGHOLZ®
7818**	745 series   C-form chairs multiplex
7818.001**	745 series   C-form chairs multiplex
7819.010**	7410 Series   C-form chairs multiplex
7822**	749 series   C-form chairs multiplex
78yz	PAGHOLZ® swivel spindle chairs
78vw.xyz	78 series   4-leg chairs PAGHOLZ®
7853	FLEX series   School chairs   Z-shaped chairs plastic shell
7854	FLEX series   School chairs   C-form chairs plastic shell
7873/7876	FLEX series   Swivel chairs   Gaslift chairs plastic shell
787w.xyz	FLEX series   School chairs   4-legged chairs plastic shell
7875	FLEX series   Swivel chairs   Spindle chairs plastic shell
7897/7898	CHANGE Series   Benches PAGHOLZ®
7899	78 series   PAGHOLZ® bar stool

For all products mentioned here, the general instructions at the beginning of the document apply. All models listed stand for the respective model series.

\* Chairs comply with test level L2 (heavy use) of DIN EN 16139.

\*\* Chairs comply with test level L1 (general use) of DIN EN 16139.



<b>MODEL</b>	<b>NAME</b>
7984.xyz	Stools   4-legged stool
793z	Stools   Rotary spindle stool
79y0	79 series   Swivel chairs   Multiplex/WOODPLAC® spindle chairs
8100	81 series   School chairs   C-form chairs plastic
8200	81 series   School chairs   4-legged chairs plastic
83yz	Gas lift chairs and stools
933z	Office swivel chairs   WAVE series   Gas lift chairs PAGHOLZ®
93xy.00z	Office swivel chairs   STANDARD and PREMIUM
937w.xyz	Upholstered swivel chair
9377.00z	Swivel spindle stool   solid wood frame, seat upholstered

For all products mentioned here, the general instructions at the beginning of the document apply. All models listed stand for the respective model series.

\* Chairs comply with test level L2 (heavy use) of DIN EN 16139.

\*\* Chairs comply with test level L1 (general use) of DIN EN 16139.

## HEIGHT-ADJUSTABLE SKID-BASE CHAIRS

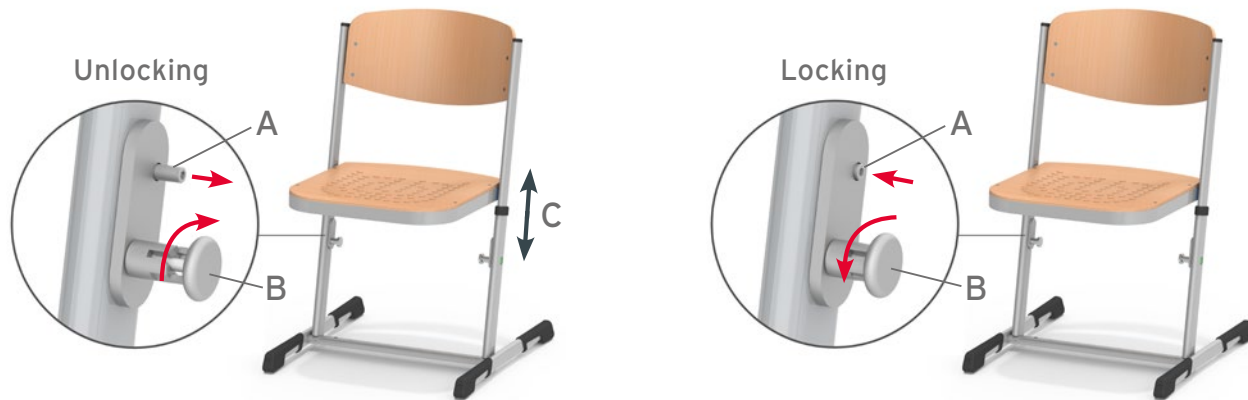

### Seat height adjustment

- Before adjusting, unscrew the grub screws (A) on both sides by approx. 0.12" with an allen key.
- Pull out both snaps (B) and turn them by 90°.
- Adjust the chair to the desired height (C). Bring both cable catches (B) back into the detent position and let them engage.
- After engagement on both sides, always tighten both grub screws (A) slightly.

## CHAIRS WITH ADJUSTABLE FOOTREST

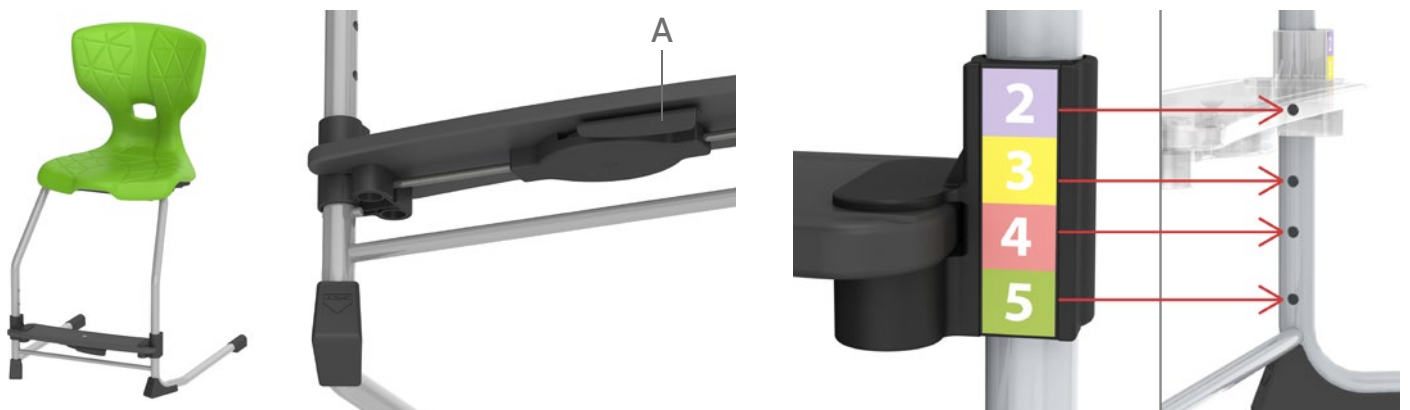

### Footrest adjustment

- The adjustment is done by one person.
- Actuate and hold the release lever (A).
- Bring the footrest parallel to the floor to the height of a detent position.
- The size label shows the adjustable seat heights (see section "Correct furniture size" under General notes).



**ATTENTION:** The adjustment may only be carried out under no load and in the area of the detent positions!

- Release the unlocking lever and let it engage. The footrest is engaged when the release lever is parallel to the edge of the footrest.

## Placing chairs on table tops

For cleaning purposes of floors the chairs can be placed on the table tops.

To do this, push the product onto the plate upside down as shown until the frame rests against the edge of the table.

 Make sure that the surface on which you are standing is in balance to prevent the chair from falling down due to slipping. Risk of damage!

 After each use, check that the product is firmly held on the table!



## Stacking the chairs

Up to three chairs can be stacked for transport or storage. Before stacking, the footrest must be brought into the appropriate detent position so that the footrests rest on top of each other:

- Lower chair to the third locking position.
- Middle chair to the second locking position.
- Upper chair to the first locking position.

 After stacking, check that the chairs are securely held!

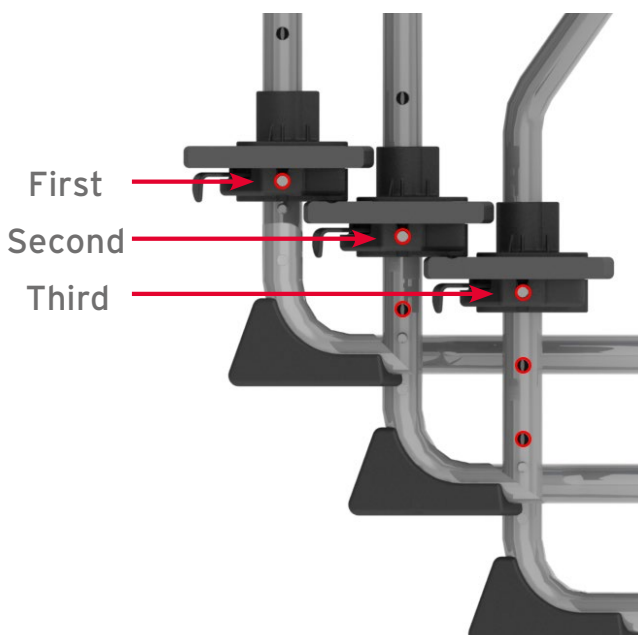

## GAS SPRING CHAIRS

### Seat height adjustment

- Actuate and hold the release lever, which is located on the right under the seat.
- Move the seat surface downwards by loading or upwards by unloading and thus continuously adjust the desired height within the adjustment range.
- Release the release lever to fix the desired height.



**ATTENTION!** Replacement and work in the area of the seat adjustment element only by trained personnel! Do not remove sliding film!

## CHAIRS WITH A WRITING SURFACE

Models 7850.012, 7874.002 and 7878

The writing surface can be folded up by 96 degrees as needed:



Please note that the writing surface may be loadet with max. 66 lb 2 oz.



**ATTENTION!** If the load on the writing surface exceeds 66 lb 2 oz, there is a risk of tipping!



## OFFICE SWIVEL CHAIRS

### Models 933z

The two release levers can be extended for easier operation if necessary by pulling them outwards.

#### Seat height adjustment

- Press and hold the release lever 2a, which is located on the right under the seat.
- Increase or decrease the pressure on the seat to lower or raise the chair to the desired height.
- Release the lever to lock in the desired height.



#### Seat tilt adjustment

- Turn the release lever 1, which is located on the left under the seat, backwards.
- Lean back to tilt the seat pan backwards to the desired incline.
- Turn the lever forward to lock in the incline position.

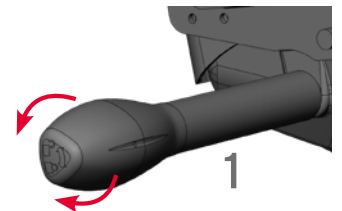

#### Adjusting the seat tilt resistance

- Turn the release lever 2b, which is located on the right under the seat, until the desired resistance is reached.
- Turning clockwise increases the resistance of the seat tilt adjustment.
- Turning counterclockwise decreases the resistance of the seat tilt adjustment.

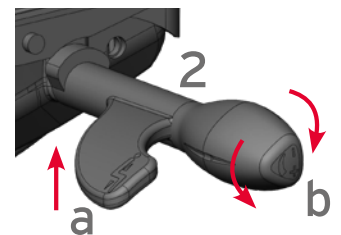

**ATTENTION! Replacement and work in the area of the gas spring only by trained personnel!  
Do not remove the sliding film!**

## STANDARD OFFICE SWIVEL CHAIRS

Models: 9352.001, 9352.002, 9352.101, 9352.102, 9353.001 and 9353.002



## MECHANICS (M)

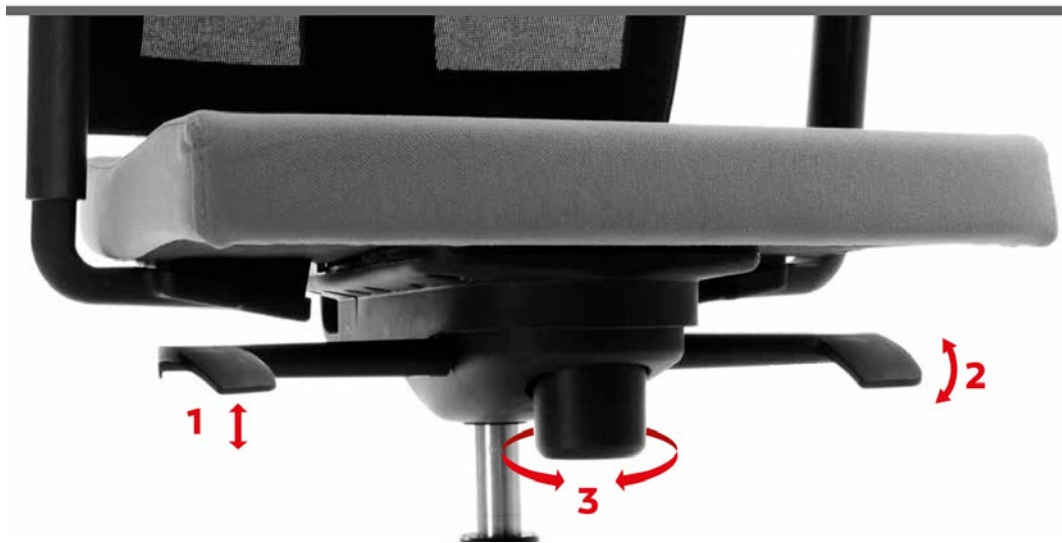

- 1 - Adjustment of the seat height.
- 2 - Adjustment of synchronous tilt of the backrest and the seat.
- 3 - Adjustment of the backrest resistance.



**ATTENTION!** Replacement and work in the area of the gas spring only by trained personnel!  
Do not remove the sliding film!

### 1 Adjustment of the seat height

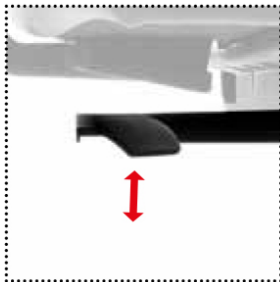
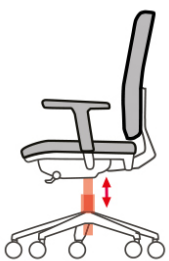

#### Lowering the seat:

1. Sit down in the chair.
2. Lift the lever up and press lightly on the seat with your thighs (the seat will slowly lower).
3. Release the lever at the selected height, to lock the position.

#### Lifting the seat:

1. Sit down in the chair.
2. Lift the lever upwards and rise slightly above the seat (the seat will slowly lift).
3. Release the lever at the selected height, to lock the position.

### 2 Synchronous backrest and seat tilt adjustment

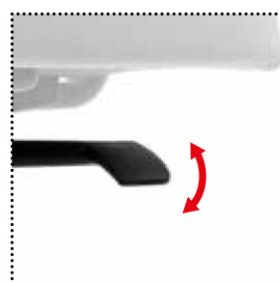

1. Unlock the mechanism by pull the lever.
2. Press your back against the backrest until you reach the desired position.
3. At the selected position, press the lever to lock the position.

## 3 Setting the resistance of the backrest

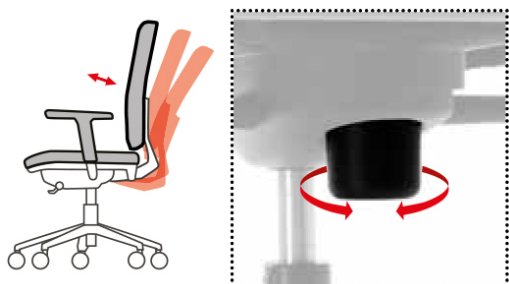

1. Stand up.
2. Turn the screw to adjust the backrest resistance to your weight.
  - a. When you are sitting in the chair, turn the screw to the right - in this way you increase the counterforce of the backrest.
  - b. When you are sitting in the chair, turn the screw to the left - in this way you decrease the counterforce of the backrest.

## ARMREST ADJUSTMENT



### Armrest, height adjustable P48B

Models: 9352.002 u. 9352.102

1. Height adjustment (range 3,15 inch)  
Press the key and simultaneously move the armrest up or down to the desired height. Release the button to leave the armrest at the specified height.

## PREMIUM OFFICE SWIVEL CHAIRS

Models: 9348.001, 9348.002, 9348.101, 9348.102, 9349.001, 9349.002, 9349.101, 9349.102, 9354.001 and 9354.002





## MECHANICS (SW)



- 1 - Adjustment of the seat height.
- 2 - Adjustment of synchronous tilt of the backrest and the seat.
- 3 - Automatic adjustment to the user's weight.
- 4 - Adjustment of the seat depth.



**ATTENTION! Replacement and work in the area of the gas spring only by trained personnel!**  
Do not remove the sliding film!

### 1 Adjustment of the seat height

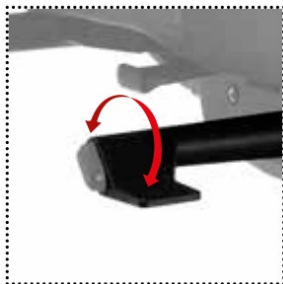

#### Lowering the seat:

1. Sit down in the chair.
2. Lift the lever up and press lightly on the seat with your thighs (the seat will slowly lower).
3. Release the lever at the selected height, to lock the position.

#### Lifting the seat:

1. Sit down in the chair.
2. Lift the lever upwards and rise slightly above the seat (the seat will slowly lift).
3. Release the lever at the selected height, to lock the position.

### 2 Synchronous backrest and seat tilt adjustment

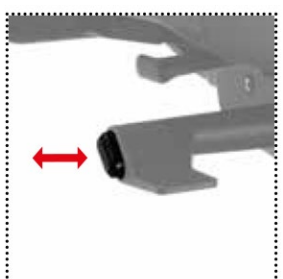

1. Unlock the mechanism by pressing the lever button.
2. Press your back against the backrest until you reach the desired position.
2. At the selected position, press the button again to lock the position.



### 3 Automatic adjustment of the backrest resistance to the user's weight

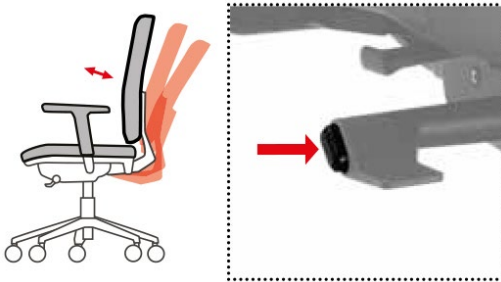

The SW-Mechanism does not require adjustment of the backrest counterforce. The mechanism detects the user's weight and automatically adjusts the synchronous recline of the backrest and seat to it.

1. Operate / lock the backrest counterforce setting.

### 4 Seat depth adjustment

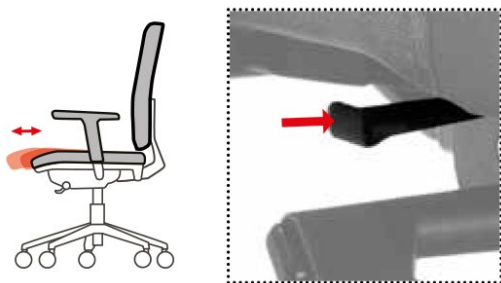

Sliding out the seat:

1. Press the push button of the lever.
2. Push the seat slightly forward with the thighs.

Slide in the seat:

1. Press the push button of the lever.
2. Push the seat slightly backwards.

### ARMREST ADJUSTMENT



#### 3D-Armrest P3DB

Models: 9348.002, 9349.002 u. 9354.002

1. Height adjustment (range 3,94 inch)

Press the key and simultaneously move the armrest up or down to the desired height. Release the key to leave the armrest at the specified height.

2. Setting the cap

Grasp only the cap and move it back and forth in a horizontal plane (2,36 inch) or sideways (20° to the left and 20° to the right)



#### 3D-Armrest P52B

Models: 9348.102, 9349.102

1. Height adjustment (range 3,15 inch)

Press the button on the outside of the armrest and simultaneously move the armrest up or down to the desired height. Release the button to leave the armrest at the specified height.

2. Setting the cap

Press the button on the inside of the cap and simultaneously move the cap forward or backward (1,97 inch range) or sideways (1,18 inch range).

## UPHOLSTERED SWIVEL CHAIR

Model 9370 - MECHANICS C



- 1 - Adjustment of the seat height.
- 2 - Adjustment of the synchronous tilt of the seat and backrest.
- 3 - Adjustment of the backrest resistance.



**ATTENTION!** Replacement and work in the area of the gas spring only by trained personnel!  
Do not remove the sliding film!

### 1 Adjustment of the seat height

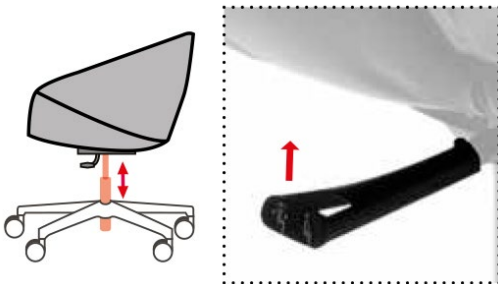

#### Lowering the seat:

1. Sit down in the chair.
2. Lift the lever up and press lightly on the seat with your thighs (the seat will slowly lower).
3. Release the lever at the selected height, to lock the position.

#### Lifting the seat:

1. Sit down in the chair.
2. Lift the lever upwards and rise slightly above the seat (the seat will slowly lift).
3. Release the lever at the selected height, to lock the position.

### 2 Synchronous tilt of the seat and backrest

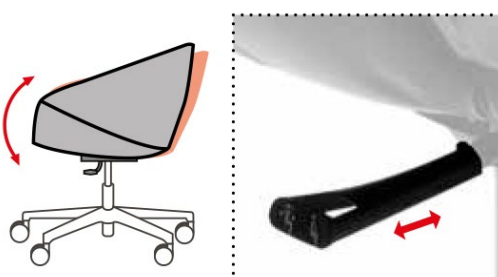

1. Unlock the mechanism by pressing the lever.
2. Press the backrest with your back until you reach the desired position.
3. With the position selected, pull the lever outward again to lock the position

## 3 Setting the resistance of the backrest

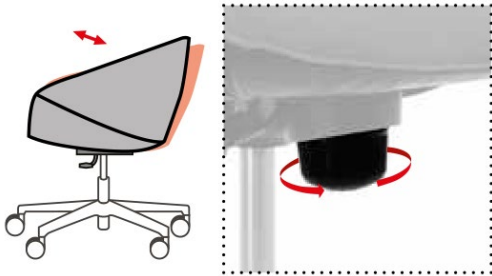

1. Stand up.
2. Turn the screw to adjust the resistance of the backrest to your weight.
  - a. When you are sitting in the chair, turn the screw to the right - in this way you increase the counterforce of the backrest.
  - b. When you are sitting in the chair, turn the screw to the left - in this way you decrease the counterforce of the backrest.

## SWIVEL SPINDLE STOOL

Model 9377.00z

The seat height can be continuously adjusted by means of a rotating spindle. To set the desired height, turn the seat body in the corresponding direction.



Do not adjust the stool while seated!



ATTENTION! Replacement and work in the area of the seat adjustment element only by trained personnel! Do not remove the sliding film!



Do not unscrew the adjustment element beyond the maximum adjustment range!

Turn clockwise  
for downward adjustment.



Turn counterclockwise  
for upward adjustment.

## PRODUCT OVERVIEW

<b>MODEL</b>	<b>NAME</b>
25vw.xyz	Cabinet elements
40tu - 46vw.xyz	Cabinet elements
49vw.xyz	Cabinet elements
45vw.xyz	Roller shutter cabinets
4033	Satchel shelves
4032	Wardrobe shelves
9119.y0z	Desk base units
9109.xyz	Rolling container
923y.z00	Rolling container
913z.080	Container with pantry pull-out
4440.200	Laptop cabinet
4440.400	Tablet cabinet
667w.xyz	Hallway cupboards
6680.00z	Seating niches for hallway cabinets

For all products mentioned here, the general instructions at the beginning of the document apply. All models listed stand for the respective model series.

## CUPBOARDS (FIXED)

### STABILITY

In order to guarantee the tilting stability of cabinets, in certain cases the cabinet or cabinets must be fixed to the wall in a stable manner! Likewise, all adjacent or superimposed cabinets must be bolted together.

#### Wall mounting

Cabinets must be fixed to the wall in the following situations:

Single cabinets or two connected cabinets to which the following applies:

- Double door wardrobes from a height of 3 file heights (4' 2"), with a depth of 1' 5.32" or less and a width of less than 1' 11.62".
- Double door wardrobes from a height of 5 file heights (6' 8.31"), with a depth of 1' 5.32" or less.
- Double door wardrobes from a height of 6 file heights (6' 8.31"), with a depth of 1' 5.32" or less.
- Shelving units and shelves from a height of 5 file heights (6' 8.31"), with a depth of less than 1' 4.54".
- Sliding door cupboards, roller shutter cupboards and shelves with a height of more than 6 file heights (8' 0.06").
- All cabinets with drawers, hanging files or other fixed pull-out elements for all sizes (lower cabinets are fixed through the rear panel)

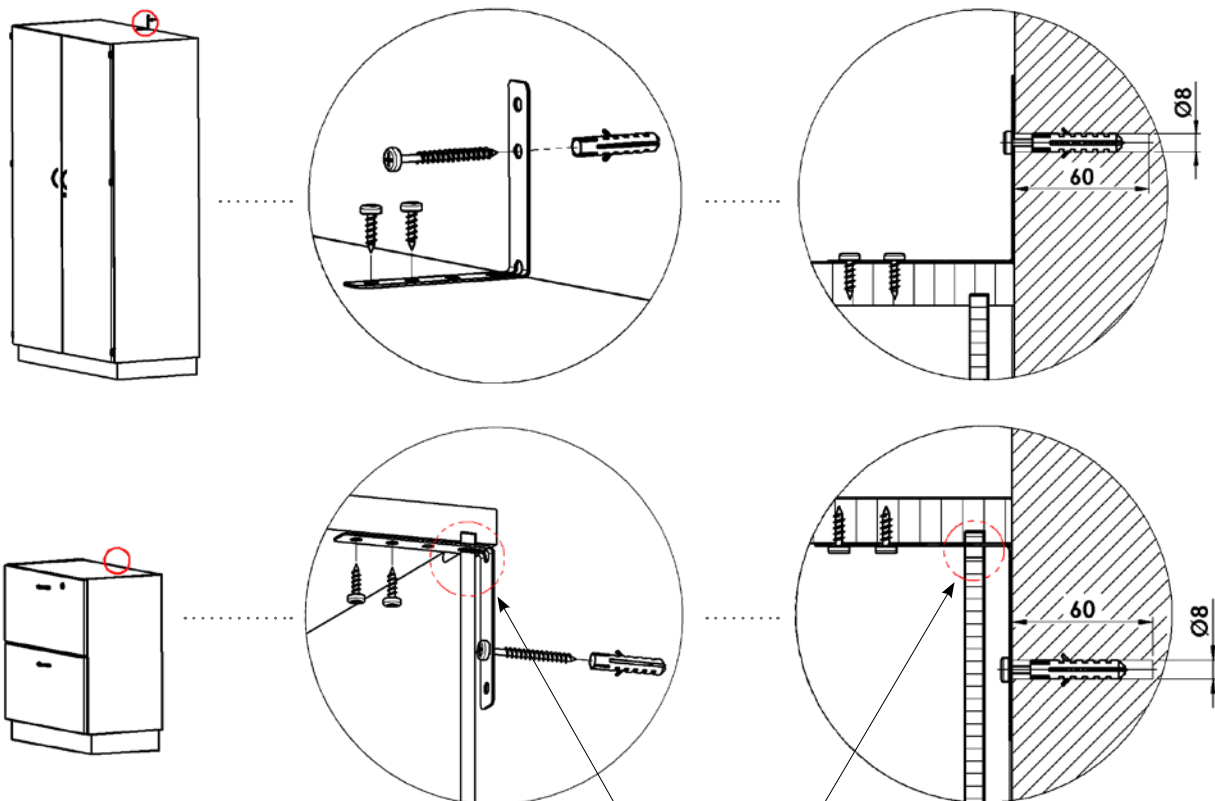

In order to make the fixing invisible, it is necessary to saw a gap in the rear wall for the fixing plate.

## General safety instructions

- Align the cabinet or cabinets before attaching to the wall.
- Several cabinets must be screwed together!
- Before dowelling, the wall conditions must be checked carefully:  
Using a suitable locating device, check that there are no electrical cables, pipes or other disturbing components in the wall so that drilling can be carried out without risk.
- The supplied screws and dowels are only suitable for solid walls (stone, concrete or similar). If the wall is made of a different material (e.g. hollow or lightweight wall), then you can find the appropriate fastening material in a specialised shop. Please get advice there.
- For free-standing cabinets and shelves, it may be necessary to secure them to the ground. You can find more information from the person who is responsible for safety.



The wall mounting may only be carried out by qualified personell!



After attaching to the wall or securing to the ground, check the cabinet's stability!

## Safety instructions for shelves

- After installing the cabinets, check shelves for secure hold in the shelf support.
- Distribute the imposed load evenly on the shelves in the cabinet.
- Heavy objects must be stored in the lower area and on the sides.
- The shelves are designed for normal use in terms of abrasion.
- Increased stress caused by rough objects (e.g. tool boxes, etc.) must be compensated for by protective measures (e.g. intermediate layers).

Cabinet Dimensions	Floor Dimension	Max. load in lb		
		Shelf		
W / D in inches	W / D in inches	0.75"	0.75"	0.98" reinforced
1' 3.75" x 1' 4.54"	1' 2.17" x 1' 2.96"	37 lb 8 oz		
1' 3.75" x 1' 10.83"	1' 2.17" x 1' 9.26"	52 lb 15 oz		
1' 11.62" x 1' 4.54"	1' 10.05" x 1' 2.96"	57 lb 5 oz		
1' 11.62" x 1' 10.83"	1' 10.05" x 1' 9.26"	81 lb 9 oz		
2' 7.50" x 1' 4.54"	2' 5.92" x 1' 2.96"		81 lb 9 oz	
2' 7.50" x 1' 10.83"	2' 5.92" x 1' 9.26"		81 lb 9 oz	
1' 11.62" x 1' 10.83"	3' 1.79" x 1' 2.96"		81 lb 9 oz	
1' 11.62" x 1' 10.83"	1' 11.62" x 1' 10.83"		81 lb 9 oz	
3' 7.31" x 1' 4.54"	3' 5.73" x 1' 2.96"			81 lb 9 oz
1' 11.62" x 1' 10.83"	3' 5.73" x 1' 9.26"			81 lb 9 oz
1' 11.62" x 1' 10.83"	3' 9.67" x 1' 2.96"			81 lb 9 oz
1' 11.62" x 1' 10.83"	3' 9.67" x 1' 9.26"			81 lb 9 oz



## WALL UNITS

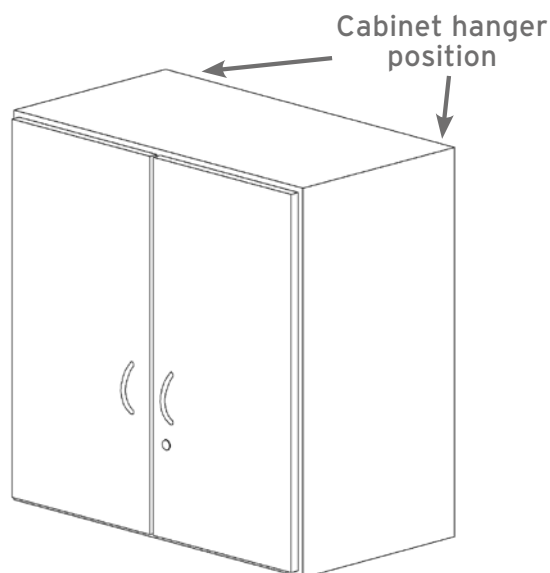

**ATTENTION:**  
Do not load the topsoil!

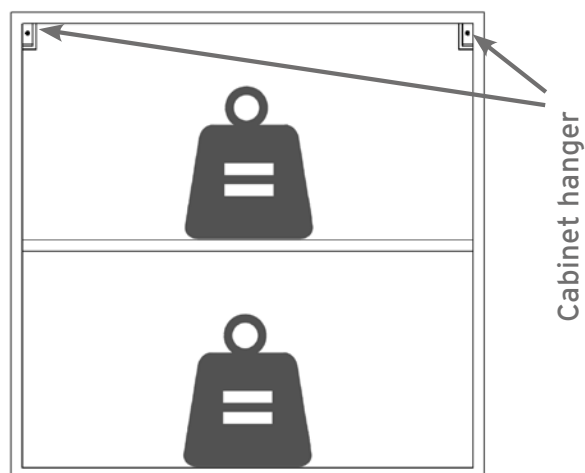

Dimensions (W / H / D in inches)	Max. load/ cabinet in lb
1' 3.75" x 1' 3.75" x 1' 4.54"	37 lb 8 oz
1' 7.68" x 1' 3.75" x 1' 4.54"	46 lb 5 oz
1' 9.65" x 1' 3.75" x 1' 4.54"	52 lb 15 oz
1' 11.62" x 1' 3.75" x 1' 4.54"	57 lb 5 oz
1' 3.75" x 2' 7.10" x 1' 4.54"	74 lb 15 oz
1' 7.68" x 2' 7.10" x 1' 4.54"	97 lb 0 oz
1' 9.65" x 2' 7.10" x 1' 4.54"	105 lb 13 oz
1' 11.62" x 2' 7.10" x 1' 4.54"	114 lb 10 oz
2' 7.50" x 1' 3.75" x 1' 4.54"	79 lb 6 oz
3' 3.37" x 1' 3.75" x 1' 4.54"	99 lb 3 oz
3' 7.31" x 1' 3.75" x 1' 4.54"	110 lb 4 oz
3' 11.24" x 1' 3.75" x 1' 4.54"	121 lb 4 oz
2' 7.50" x 2' 7.10" x 1' 4.54"	158 lb 12 oz
3' 3.37" x 2' 7.10" x 1' 4.54"	176 lb 6 oz
3' 7.31" x 2' 7.10" x 1' 4.54"	176 lb 6 oz
3' 11.24" x 2' 7.10" x 1' 4.54"	176 lb 6 oz

- Loading of the wall cabinet only with the maximum payload permitted for the model.
- The maximum permissible load of the shelves must not be exceeded.
- The cabinet dimensions for determining the maximum payload indicated in the table are given in the delivery documents.
- The imposed load must be distributed evenly in the cabinet.
- Nothing may be placed on the top of the wall cabinet.
- If necessary, use suitable climbing aids such as steps or fixed ladders (no single ladders!).
- Do not hold on to the cupboard or the door!
- Do not store hazardous substances in the cabinet!



Sum of the loads per shelf = Max. load of the wall cabinet

## SAFETY INSTRUCTIONS

### Components on the wall

Before drilling, it must be ensured with a suitable locating device that there are no electrical cables, pipes or other components in the area of the hole.

### Strength of the wall

Before mounting, make sure that the wall is suitable for the supplied fasteners. The plugs and screws supplied are only intended for solid building materials (stone, concrete or similar). For other building materials (e.g. lightweight construction walls), suitable fasteners must be used. If the wall conditions are difficult, an optionally available suspension rail (C) should be used instead of the supplied support plate (B) to ensure secure mounting.

### Hanging the wall cabinet

Only suitable fasteners (screws, hooks, dowels) may be used. The cabinet hanger (A) must engage securely behind the support plate (B) or the suspension rail (C). The cabinets must be aligned horizontally. Several cabinets hanging next to each other can be connected with each other.

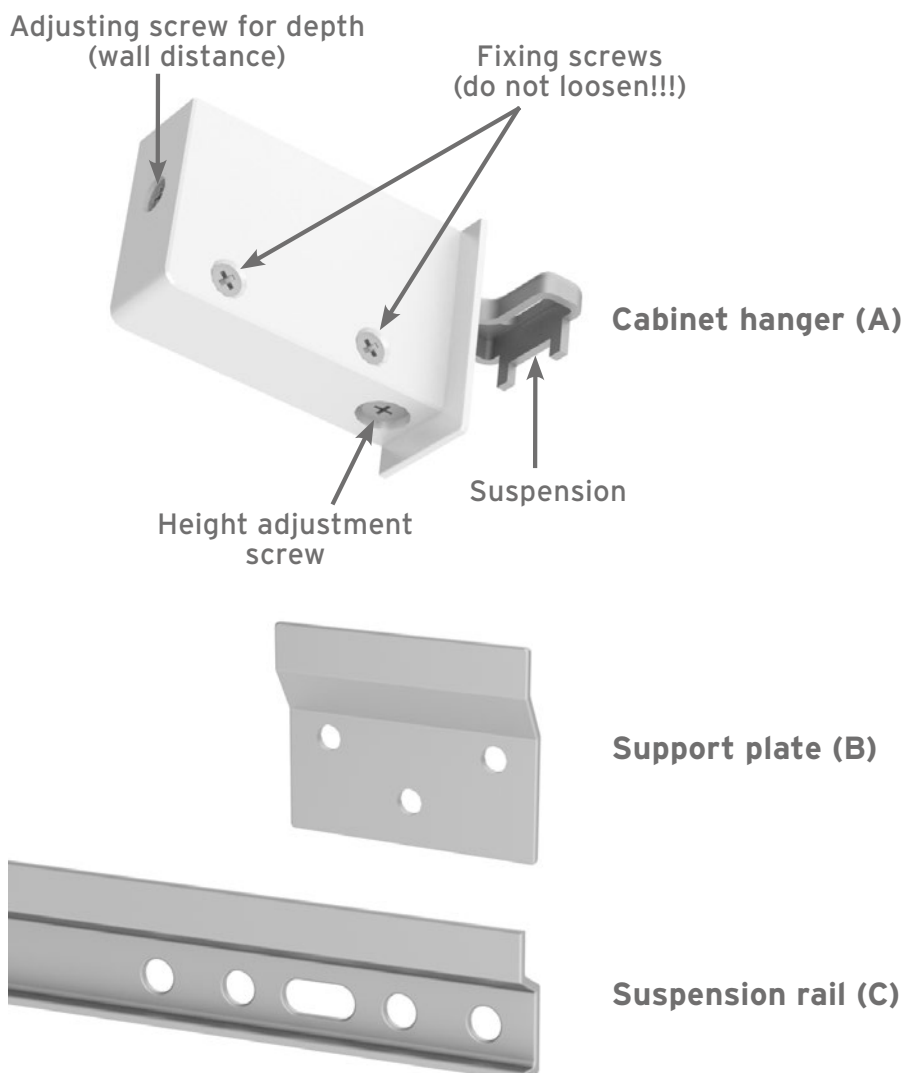



## MOBILE CUPBOARDS

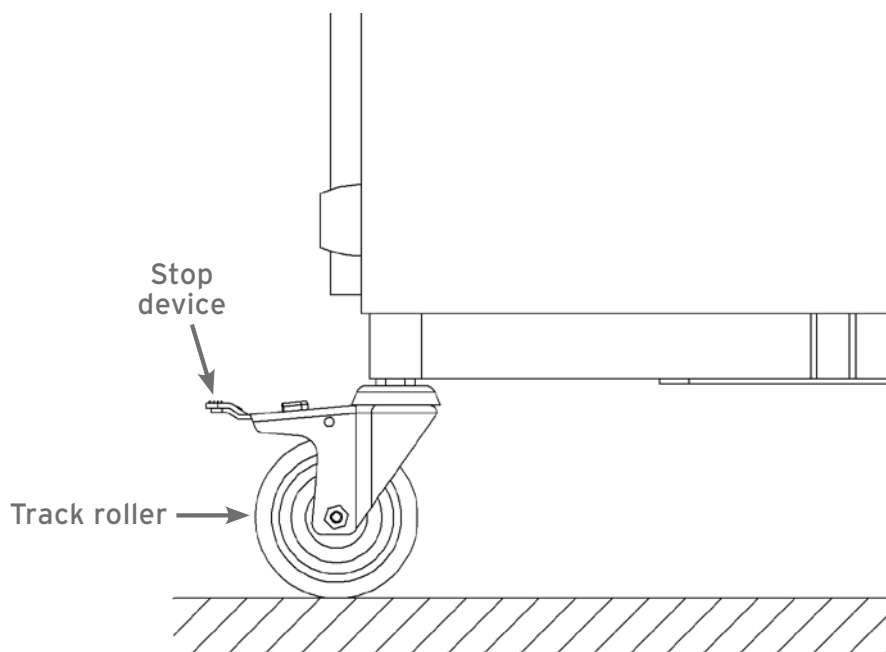
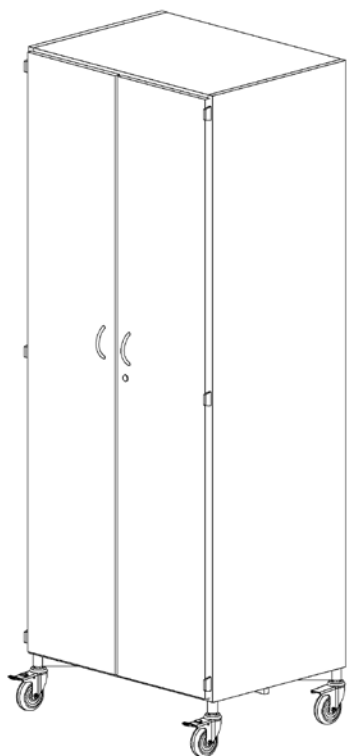

## SAFETY INSTRUCTIONS

- Mobile cabinets are not a means of transport. The possibility of the procedure serves a flexible use of space and not the daily transport. They are therefore only to be used as intended. The storage of hazardous substances and liquids is not permitted.
- The cabinets may only be moved by trained personnel. This should always be done by two people.
- The route must first be checked for obstacles and trip hazards (electric cables, loose floor coverings or similar).
- The use is limited to the interior area. Moving on unsuitable floors such as pavement will damage the castors.
- Special care is required when driving over obstacles such as door thresholds. Driving on ramps and parking on inclined surfaces is not permitted.

## ROLLERS AND STOPPING DEVICE

- When putting the cabinet down, the castors must always be aligned to the front, i.e. towards the usage side.
- The stop device must always be operated to secure the cabinet against rolling away. It is a total locking device that locks both the rolling movement of the castor and the rotation of the castor on the frame.
- The track rollers must not come into contact with chemicals such as petrol, oil, solvents or aggressive cleaning agents.

The load capacity of the rollers is designed for the respective cabinet type and its maximum load. Overloading leads to damage to the rollers and endangers the stability of the cabinet. No abrasive or caustic cleaning agents may be used for furniture and castors. It is not necessary to lubricate the moving parts.

## LOAD ON SHELVES

The permissible load capacity per shelf is shown in the table in the section "Safety instructions for shelves". Heavy objects must always be stored at the bottom, light objects at the top.

## MOVING OF MOBILE CABINETS

Before proceeding, make sure that...

- ... the permissible load of the shelves is not exceeded.
- ... no objects can fall out of open (shelf) cupboards.
- ... there are no objects on top of the cupboard.
- ... the doors are closed.
- ... the stop device on the rollers is released.

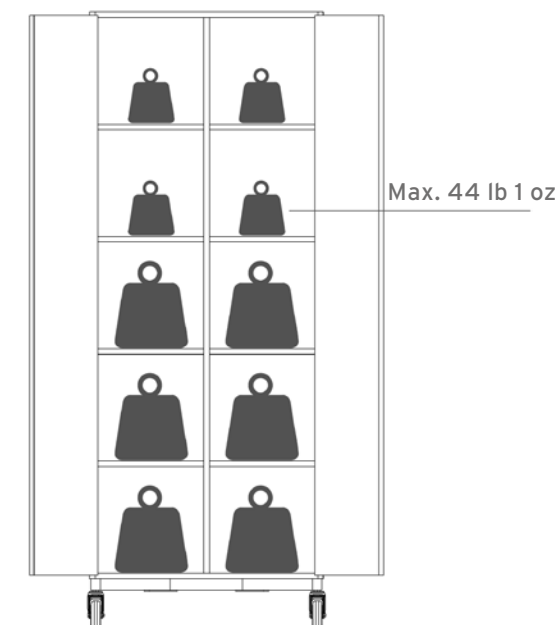

 Alignment in the direction of the cabinet width must be slow. Danger of tipping!

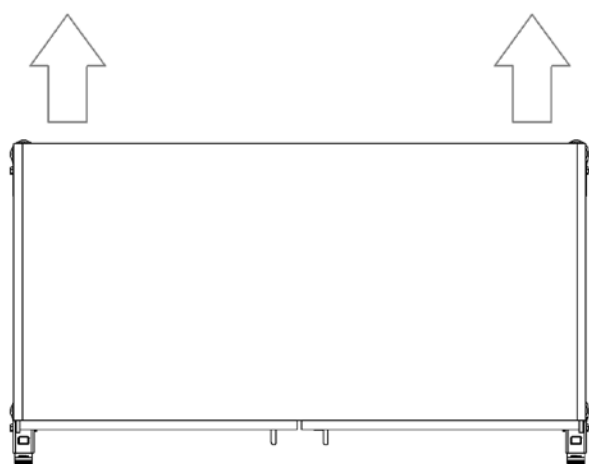

Always move in the direction of the narrow side!

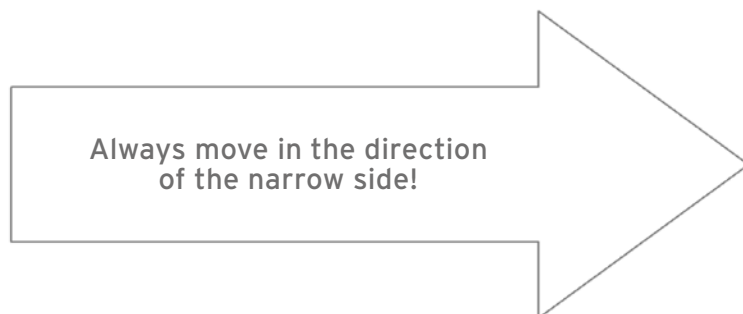

## SHELVES



### SAFETY INSTRUCTIONS

#### Components in wall or ceiling

Before drilling, it must be checked with a suitable locating device that there are no electrical cables, pipes or other components in the area of the hole.

#### Strength of wall or ceiling

Before mounting, check whether the wall or ceiling is suitable for the supplied fasteners. The supplied dowels are only intended for solid building materials (stone, concrete or similar). For other building materials (e.g. lightweight walls), suitable dowels must be used.

#### Shelf mounting

When installing in front of the wall, always attach both outer columns and every second column in the row to the wall. In the case of free-standing installation, each stand column must be fixed to the ceiling. From a height of 7' 2.61" a third frame must always be mounted. The maximum profile length is 9' 10.11".

### WALL MOUNTING

Align the stand column (1) vertically. Put the mounting bracket (3) onto the screw (4), mark and drill the hole on the wall. Fix the mounting bracket to the wall with screw, washer and dowel (6 + 7 + 8). Then secure with nut (5).

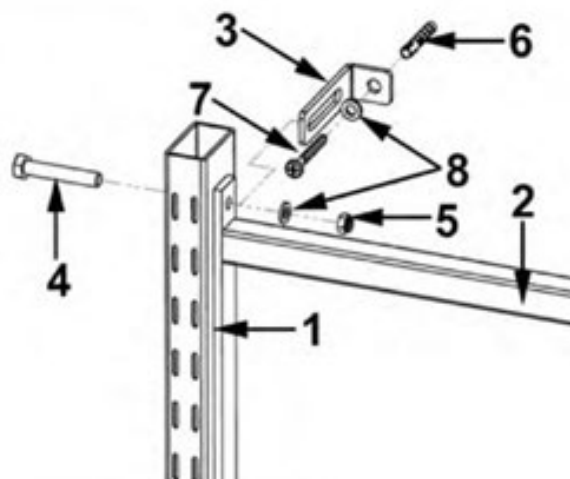

## CEILING MOUNTING

Insert the mounting bracket (3) into the upright column (1), align the upright column vertically, mark and drill the hole on ceilings. Then mount frame (2) with screws (4) and nuts (5). Fasten the mounting bracket to the ceiling with screw, washer and dowel (6 + 7 + 8).

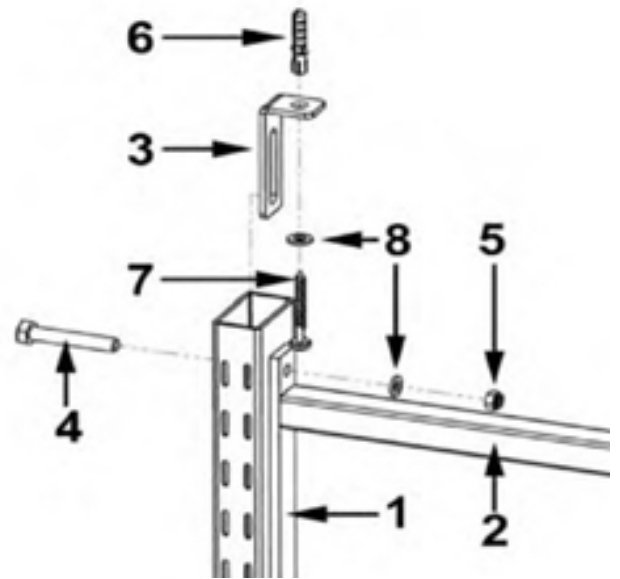

## SHELF USAGE

The maximum load capacity is given in lb/field (area of the shelf between two upright columns). The field width is 2' 7.50". Depending on the depth of the shelf, different loads must therefore be taken into account. Free-standing shelves must be loaded evenly.

If necessary, suitable climbing aids, such as steps or block ladders, must be used. Do not use single ladders or climb the shelf!

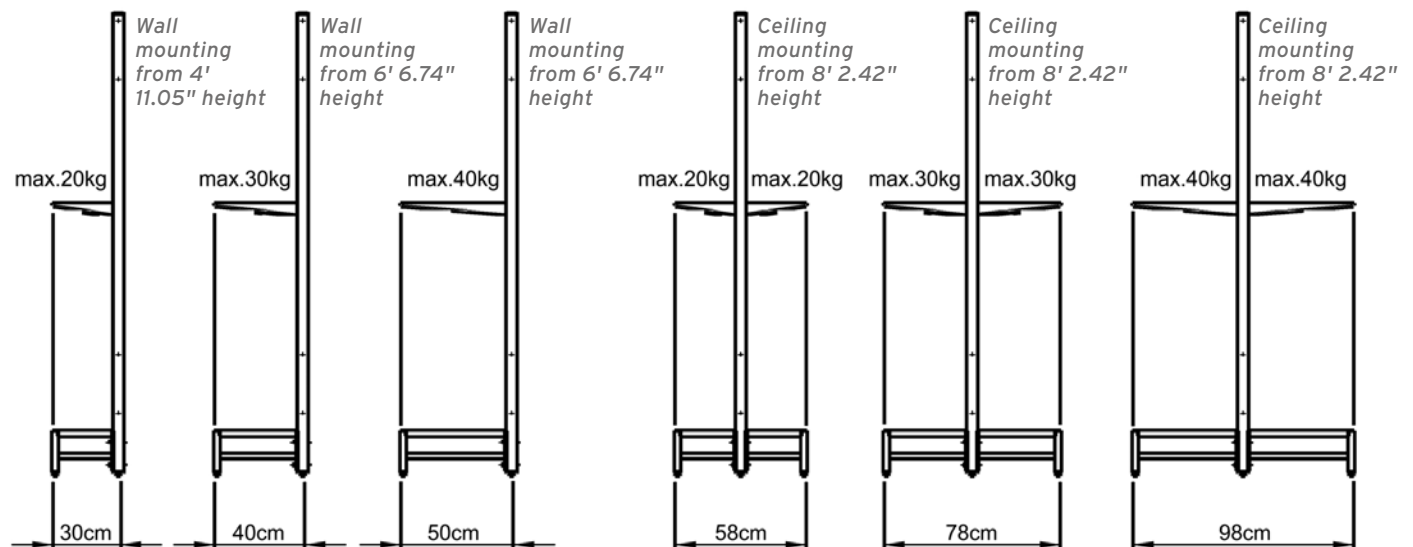

## SUSPENSION FILING CABINETS

Models 416w.xyz

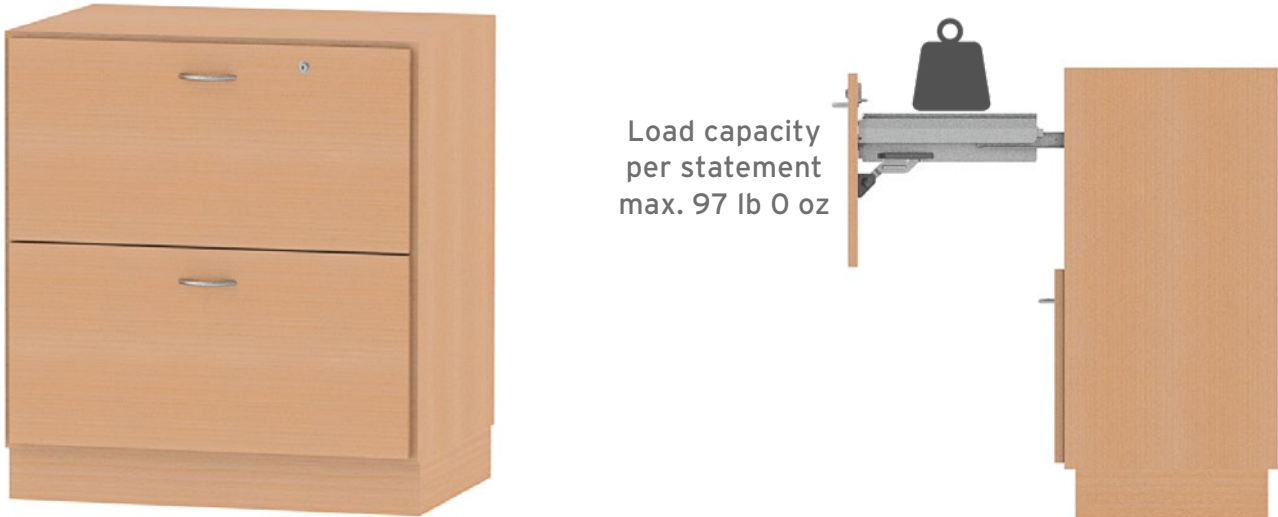

- Observe the maximum permissible load on the pull-outs.
- Distribute the weight of the payload as evenly as possible in the cabinet.
- Check screw connections at regular intervals (e.g. 1x yearly).
- The pull-out stop prevents several drawers from being pulled out at the same time, thus ensuring the stability of the cabinets



All hanging filing cabinets must be wall-mounted. Danger of tipping!

## ROLLING CONTAINER



The utensil drawer can be loaded with a maximum of 11 lb 0 oz.



Single drawers can be loaded with max. 33 lb 1 oz, full and over-extension drawers and shelves with max. 55 lb 2 oz.



The pull-out stop prevents several pull-outs from being pulled out at the same time and thus ensures the stability of the container.

- Use containers only as intended.
- Check screw connections and rollers at regular intervals (e.g. 1x per year).
- Always secure containers on level surfaces against unintentional rolling away by locking the castors.
- Containers can be moved by one person when unloaded and by two persons when loaded by gripping the body.
- Movement within the room is possible when loaded, but the rollers are not designed for regular transport over longer distances.
- Observe max. loads on the pull-outs!



Do not stand on containers. Risk of accident!



Do not use the pull-out handles for moving or carrying. Risk of damage!

### Weight data according to model:

Model no.	Own weight	Total weight	Model no.	Own weight	Total weight
9109.601	63 lb 9 oz	173 lb 12 oz	9231.600	86 lb 0 oz	185 lb 4 oz
9109.603	63 lb 11 oz	173 lb 15 oz	9231.800	104 lb 13 oz	203 lb 16 oz
9109.604	81 lb 9 oz	180 lb 12 oz	9232.600	68 lb 7 oz	178 lb 11 oz
9109.605	38 lb 12 oz	149 lb 0 oz	9232.800	93 lb 8 oz	203 lb 12 oz
9109.801	86 lb 15 oz	197 lb 3 oz			
9109.803	87 lb 1 oz	197 lb 5 oz			
9109.804	98 lb 1 oz	197 lb 4 oz			
9109.805	49 lb 0 oz	159 lb 4 oz			

## DESK BASE UNITS



The utensil drawer can be loaded with a maximum of 11 lb 0 oz.

Single drawers can be loaded with max. 44 lb 1 oz, full and over-extension drawers with max. 88 lb 3 oz, and shelves with max. 55 lb 2 oz.

- Use containers only as intended.
- Check tables for sufficient load capacity before assembly.
- Check screw connections at regular intervals (e.g. 1x yearly).
- Observe max. loads on the pull-outs!

### Weight data according to model:

Model no.	Own weight	Total weight
9119.801	71 lb 11 oz	215 lb 0 oz
9119.803	71 lb 14 oz	215 lb 3 oz
9119.804	67 lb 11 oz	211 lb 0 oz
9119.805	48 lb 13 oz	159 lb 0 oz
9119.701	67 lb 5 oz	210 lb 10 oz
9119.703	67 lb 7 oz	210 lb 12 oz
9119.704	63 lb 5 oz	206 lb 10 oz
9119.705	42 lb 15 oz	153 lb 2 oz

## CONTAINER WITH PANTRY PULL-OUT

Models 913z.080



- Use containers only as intended.
- No wall or table mounting necessary.
- Check screw connections at regular intervals (e.g. 1x yearly).
- Operate the pull-out only by the handle.
- Maximum load per container 33 lb 1 oz.



Before closing the drawer, make sure that all plastic boxes and internal drawers are properly inserted and that no objects protrude beyond the inner body!  
Risk of damage!



## LAPTOP CABINET

Model 4440.200

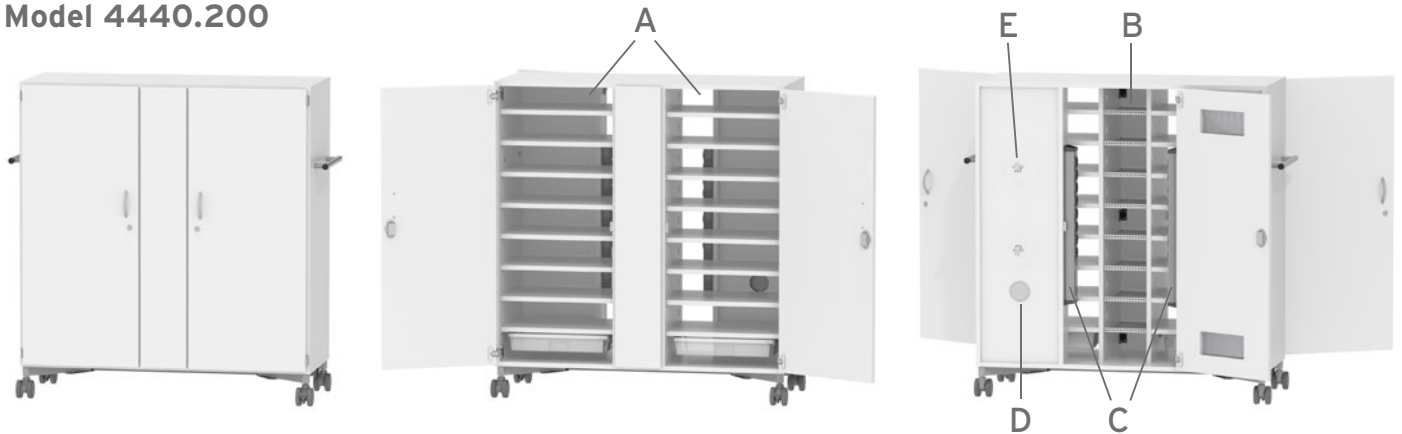

- Only use the cabinet for its intended purpose.
- Always secure the cabinet on level surfaces against unintentional rolling away by locking the castors.
- Piece of furniture is designed for simultaneous charging of up to 16 laptops.
- Do not store liquids or cleaning agents in this piece of furniture.
- Due to heat emission, all power supply units must be stowed exclusively on the metal grid shelves provided for this purpose.
- The piece of furniture (own weight 264 lb 9 oz / total weight max. 440 lb 15 oz) can be pushed by two persons when loaded with the help of the handles attached to the side of the cabinet. Do not lift or carry furniture by the handle!



Before moving the cabinet, disconnect the power cord! Securely attach the power cable to the cable holder provided and lock the doors!

### Charging the laptops

- Insert laptops into the designated compartments (A) on the front, only one device per compartment!
- Place the power supply units from the rear on the metal grid shelves (B) and connect them to the socket strips (C) in the cabinet.
- If not already done, pull the mains cable out of the cabinet via the cable gland (D).
- To begin charging the laptops, run the power cord from the laptop cabinet to the wall outlet and plug it in.
- Avoid possible tripping hazard due to power cord.



The power supply of the laptop cabinet is switched on and off via the mains cable. The charging process starts when the power cable of the cabinet is connected!

- Finally, close and lock the doors.
- After charging, disconnect the power cable from the wall socket and attach it securely to the cable holder (E) at the rear of the cabinet.

Technical data:	
Nominal voltage:	230V~
Continuous load:	8A ( 1800W )

## TAPLET CABINET

Model 4440.400

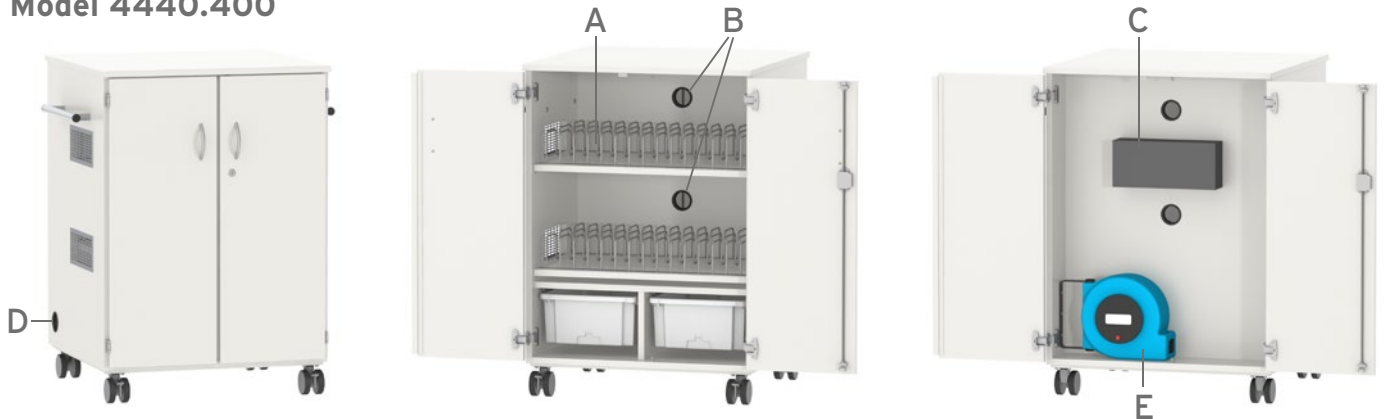

- Only use the cabinet for its intended purpose.
- Always secure the cabinet on level surfaces against unintentional rolling away by locking the castors.
- Piece of furniture is designed for simultaneous charging of up to 28 tablets.
- Do not store liquids or cleaning agents in this piece of furniture.
- The piece of furniture (own weight 187,39 lbs / total weight max. 440,92 lbs) can be pushed by two persons when loaded with the help of the handles attached to the side of the cabinet. Do not lift or carry furniture by the handle!



Before moving the cabinet, disconnect the power cable and store it safely in the cabinet using the cable winder provided for this purpose, and lock all doors!

### Charging the tablets

- Insert tablets vertically into the compartments (A) provided for this purpose on the front side, only one device per compartment!
- Pull the connection cables of the devices through the openings (B) in the rear panel to the rear and plug them into the USB charger (C) from the rear.
- If not already done, pull the mains cable out of the cabinet via the cable gland (D).
- To begin charging the tablets, run the power cord from the tablet cabinet to the wall outlet and plug it in.
- Avoid possible tripping hazard due to power cord.



The power supply of the tablet cabinet is switched on and off via the mains cable. The charging process starts when the power cable of the cabinet is connected!

- Finally, close and lock the doors.
- After charging, disconnect the mains cable from the wall socket and safely store it in the cabinet using the integrated cable winder (E). To do this, pull the mains cable out a small distance to activate the winding mechanism and then let the cable slide slowly into the cabinet.

Technical data:	
Nominal voltage:	230V~
Continuous load:	8A ( 1800W )

## HALLWAY CUPBOARDS

### Models 667w.xyz

Depending on the equipment variant, the wardrobes have triple hooks for hanging garments and a stool as a climbing aid or seat. The following must be taken into account:

- The maximum permissible load per triple hook is 33 lb 1 oz.
- Stools have a pull-out stop in the area of the floor glides. This limits complete pull-out and thus prevents unintentional blocking of possible escape routes in the corridor area.
- The stool must be pulled out as far as it will go before it is used as a climbing aid or seat in order to ensure that it stands securely.
- Before closing the hinged doors, check that the stool and other fittings have been fully inserted to avoid possible damage to the hinged doors!



## WARDROBE SHELVES

### Models 4032.z41

The shelves have a triple hook for hanging articles of clothing.

- The maximum permissible load per triple hook is 33 lb 1 oz.

 Do not get into the shelf! Never use interior dividers as a climbing aid!



## SCHOOL SACHEL SHELVES

### Models 4033.yz0

The storage compartments of the school satchel shelves with castors may be loaded with max. 33 lb 1 oz per compartment.

For satchel shelves without castors, the permissible load capacity per shelf can be found in the table in the "Safety instructions for shelves" area.

If your piece of furniture has castors, please also note the safety instructions from the "Mobile cabinets" section in this document.

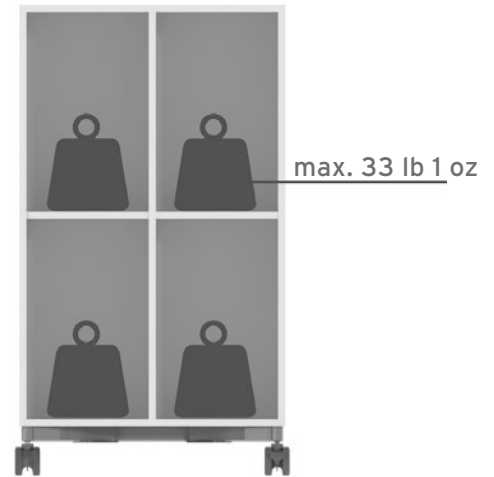

## HINGE ADJUSTMENT FOR HINGED DOORS

The hinges are optimally pre-set at the factory before delivery. Depending on the unevenness of the floor or the life span of the product, readjustment may be necessary on site. Before adjusting the hinges, make sure that the cabinet is in balance. Depending on the purchased product or order, different hinges may be installed.

### Single pivot hinge with visible roller (opening angle 270°)

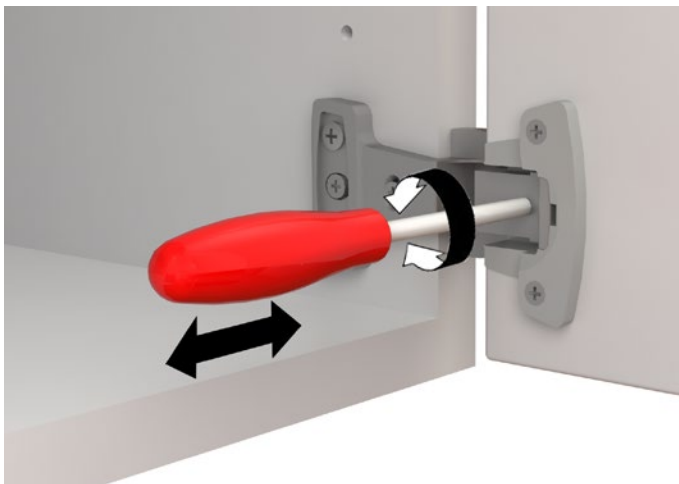

Side adjustment

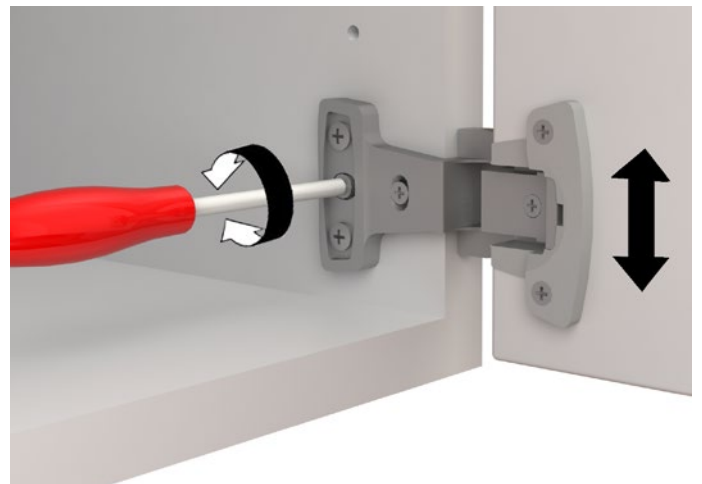

Height adjustment

### Single-joint hinge with visible roller (hallway cupboards only)

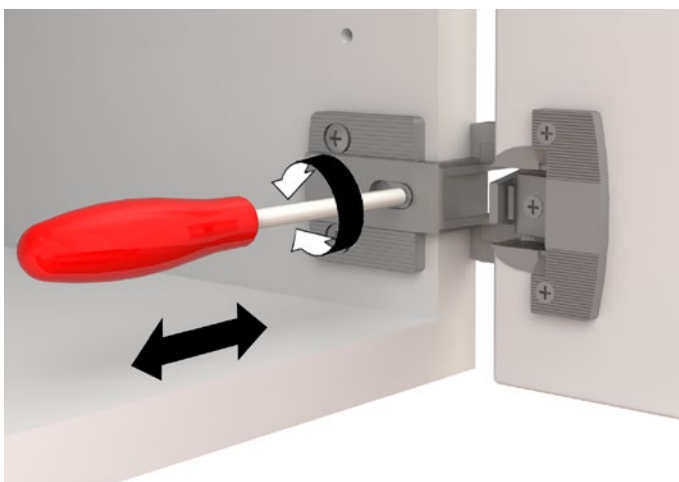

Side adjustment

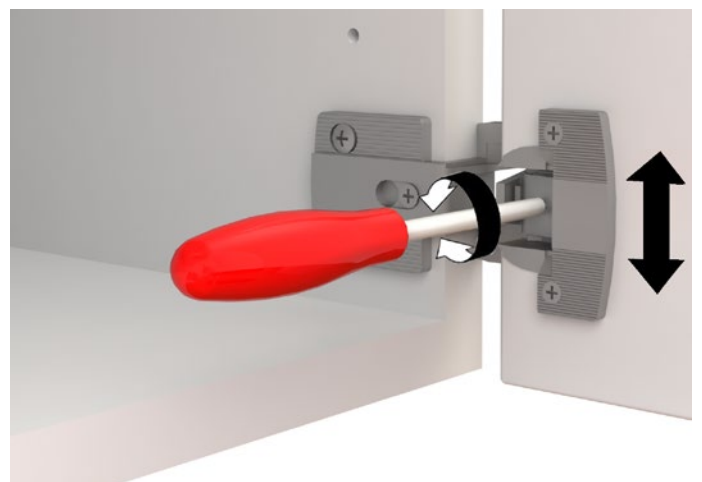

Height adjustment

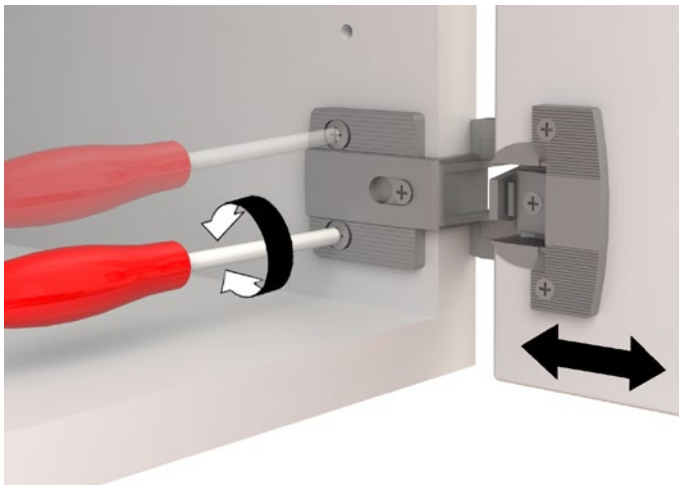

Depth adjustment

## Concealed hinge (opening angle 110°)

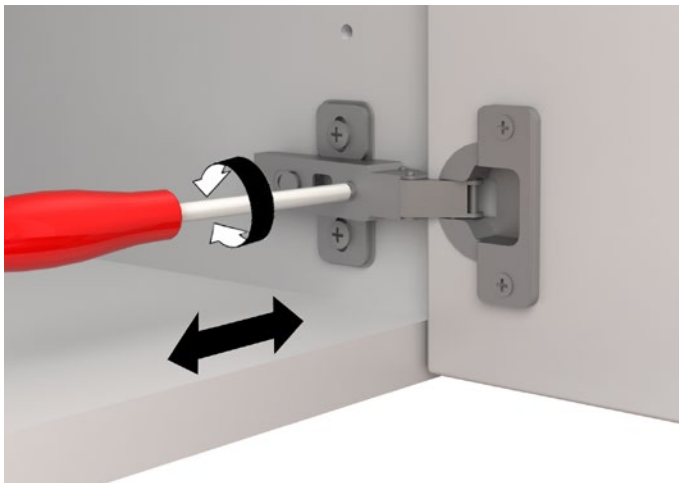

Side adjustment

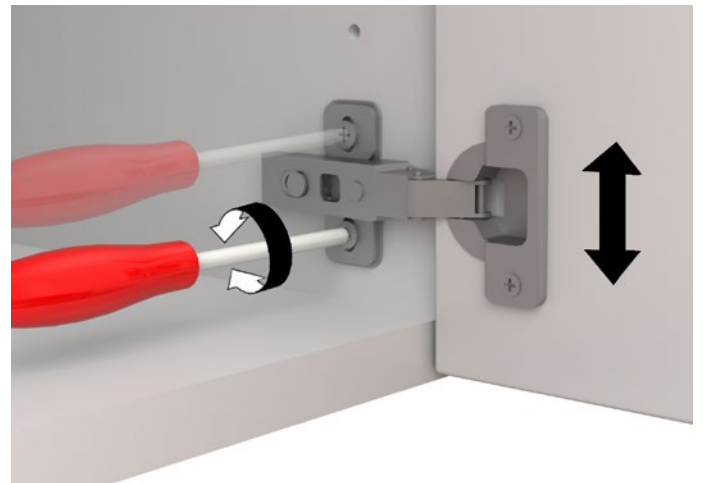

Height adjustment

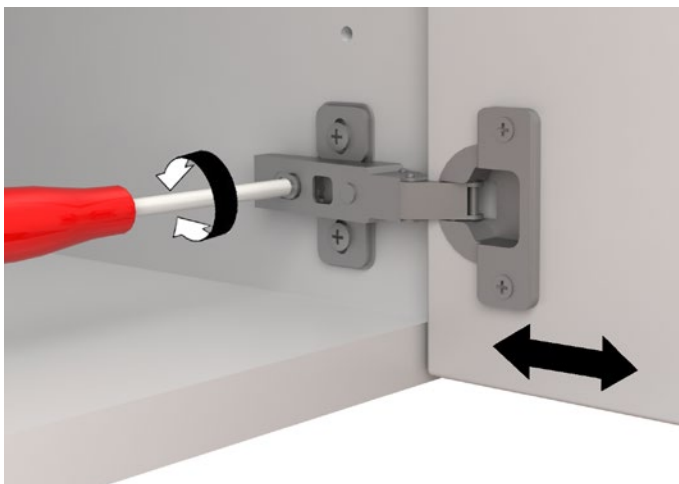

Depth adjustment

## PRODUCT OVERVIEW

<b>MODEL</b>	<b>NAME</b>
501z	Series COCOON
501x.0yz	Series JOYN
938w.xyz	Series MODULA Wall elements
46x0.5yz	Series MODULA Shelves
313y.0z4	Series MODULA Tables
9358.xyz	Series BLOC
9359.xyz	Series CYLINDA
9384.xyz	Series DOMINO
9385.xyz	Series DOMINO HOUSE
9387.xyz	Series MAZE
9396.xyz	Series COMFORT HI

## DOMINO SERIES

Models 93vw.xyz

The 9384.xyz DOMINO series modules can be equipped with 9385.xyz back panels. These act as visual and sound barriers. The modules can stand individually or be linked together using furniture connectors. Seat formations consisting of several modules placed next to each other are thus to can be secured against unintentional movement.

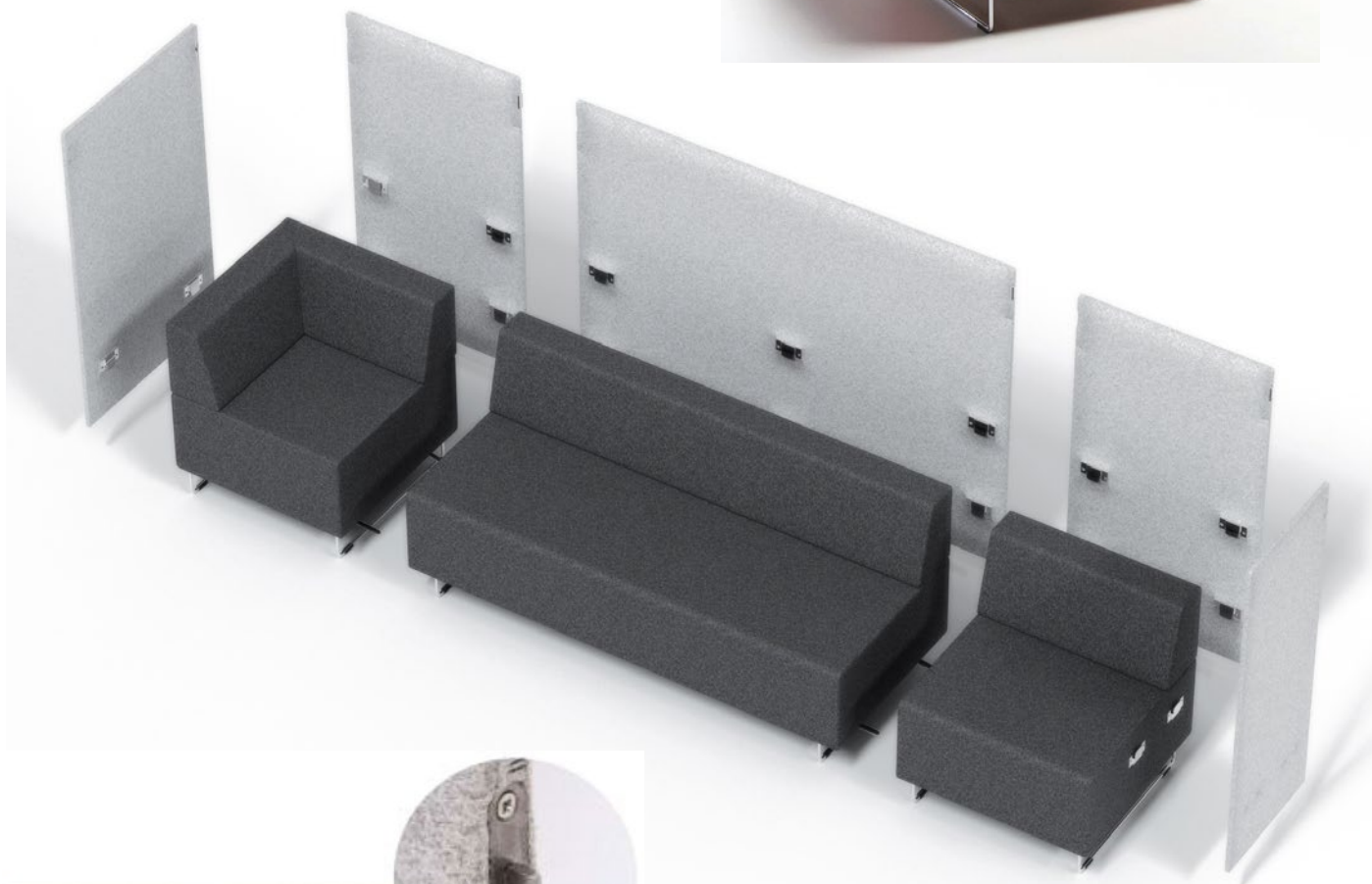

### Fastening the back panels

The rear walls can be attached without tools by inserting them into the holders on the upholstery element from above.

The rear walls also have holders on the contact surface in the upper area, which are simply hooked together to provide the walls with more stability.



## Linking the upholstered elements

Individual modules are linked via pre-assembled furniture connectors.

Part 1 is mounted on one side of the element, part 2 on the other side.

To connect, first unfold part 1.

Then part 1 is pushed into part 2 and locks into place.

To release the connection, the padding element is slightly lifted with part 2. Then part 1 can be folded away again.

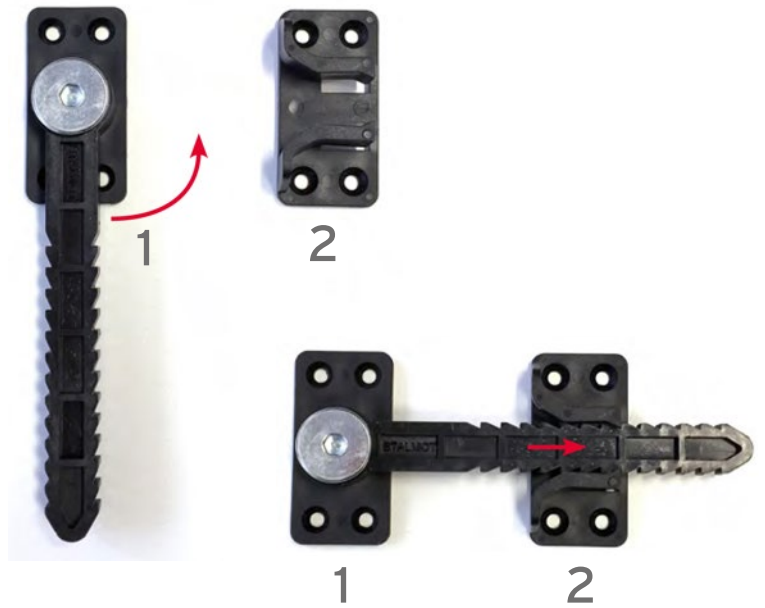

## COMBI ACOUSTIC PARTITION WALL SYSTEM

Models 6710.xyz

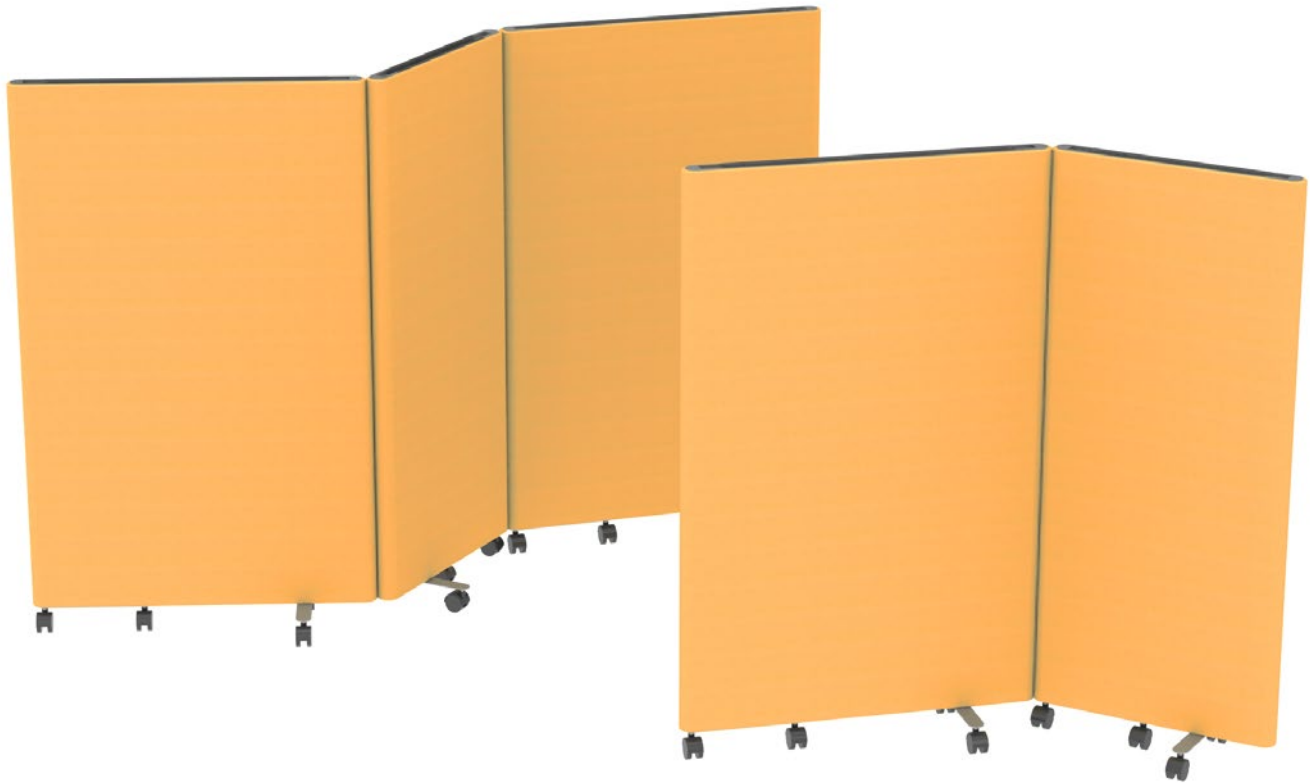

### Connecting the partitions



Up to 4 partitions can be linked together quickly and easily without tools using multiple connectors.

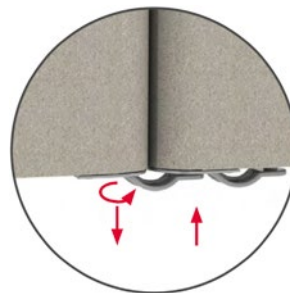

Pull the connector from the bottom of the first wall, turn it at the pivot point to the second wall and fasten it there.

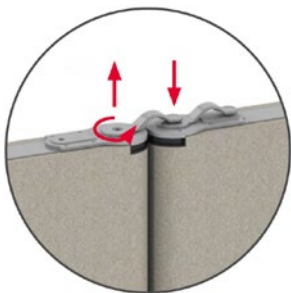

Lift the connector from the top of the first wall, turn it at the pivot point to the second wall and fasten it there.

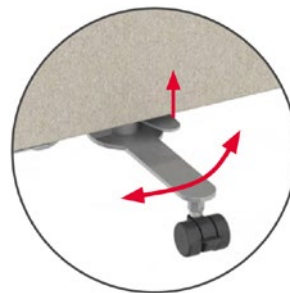

The feet with outriggers are rotatable and optionally available with castors.

Lift the anti-rotation lock and adjust the boom individually, then release the lock.



Fold in max. one foot when connecting the partitions. When chaining, the foot should preferably be folded in at an angle. Always fold out the feet to move the partitions! When folding out, make sure that it is locked!

## MULTIFUNCTIONAL BOARD SYSTEM

Models 6814.xyz

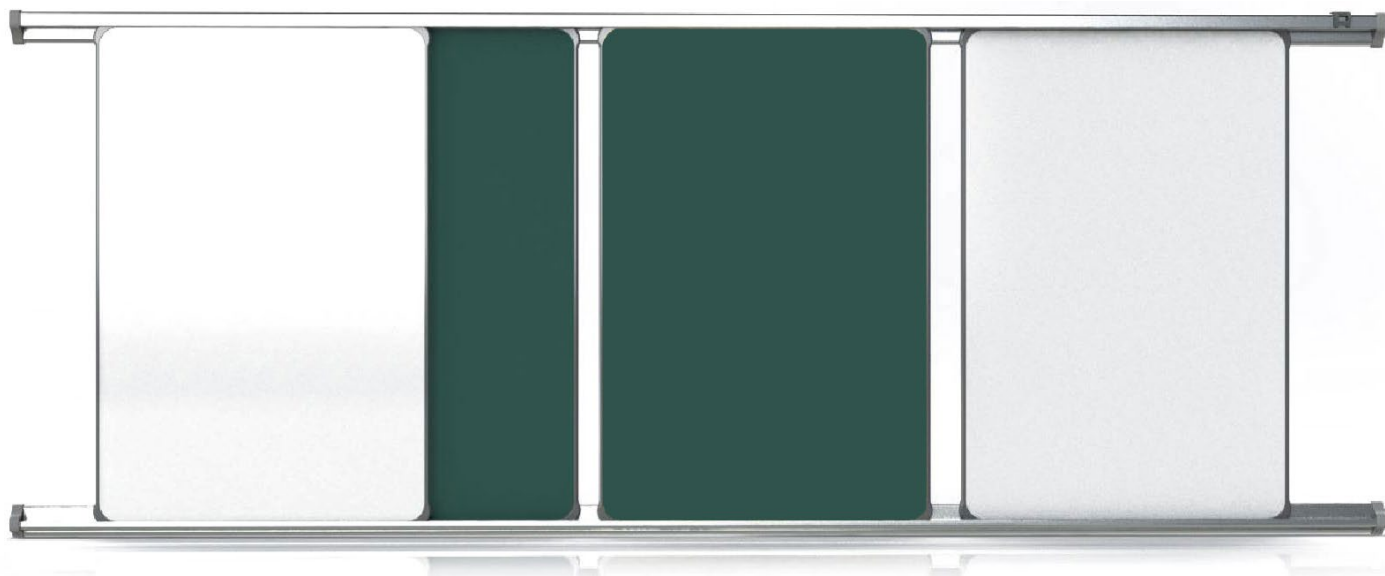

### General safety instructions

- Before dowelling, the wall conditions must be checked carefully:  
Using a suitable locating device, check that there are no electrical cables, pipes or other disturbing components in the wall so that drilling can be carried out without risk.
- Before mounting the panel system, check that the wall is suitable for the supplied fasteners. The supplied dowels are only suitable for solid walls (stone, concrete, etc.). Suitable dowels must be used for hollow or lightweight walls.



**Do not remove the sliding film in the rail!**

### Mounting and removing boards

- Thread the panel element (A) into the upper guide rail (B) in the desired plane (front or rear).
- Push panel element (A) upwards until it can be inserted into the lower guide rail (C) at the same level.
- The unhooking is done in reverse order.

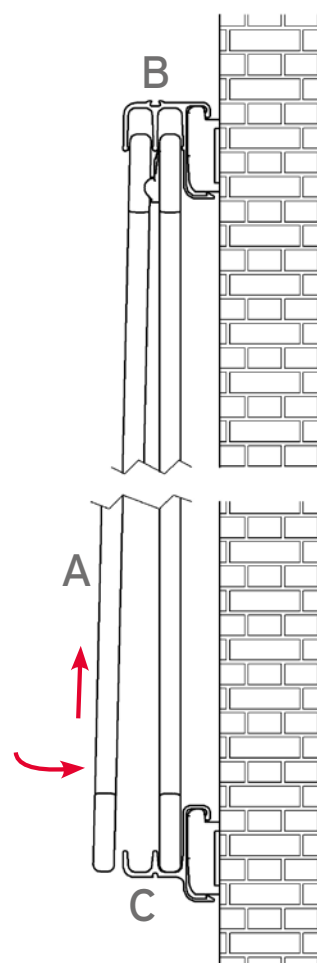

# DER BILDUNGSEINRICHTER

## You need accessories or spare parts for your A2S furniture?

In our service catalogue, you will find all items regarding maintenance, care and service on more than 200 pages.

Order hotline:

Phone: +49 9265 808-0

Fax: +49 9265 808-201

E-mail: [info@a2s.com](mailto:info@a2s.com)



A2S Inc.

62-64 Enter Lane

Islandia, NY 11749

Phone 631.501.1057

A2S Furnishing Systems

ASS Einrichtungssysteme GmbH

Po. Box 1154

96338 Stockheim

Germany

Phone: +49 9265 808-0

Fax: +49 9265 808-201

E-mail: [info@a2s.com](mailto:info@a2s.com)

Internet: [www.a2s.com/us](http://www.a2s.com/us)

See title page for current edition.  
Errors and technical changes reserved.